



General Features



Functionality and Quality Hidden in Every Detail...

- *Fantürk FKS Series Air Handling Units are manufactured in 28 different sections. Flow Rate range is $900 \text{ m}^3 / \text{h}$ - $145.000 \text{ m}^3 / \text{h}$ for cooling and ventilation units and 900 - $194.000 \text{ m}^3 / \text{h}$ for heating units only.*
- *Air Handling Units manufacturing with modular type and have double-skin panels.*
- *According to demand and application, rockwool, glasswool or polyurethane insulation, 50 mm or 60 mm thickness can be used for panels.*
- *Exterior skins are coated in RAL 9002 color as standard and for inner skins galvanized, painted or stainless steel can be used according to the request and application.*
- *Thanks to its flat inner surface, it is easy to clean and prevents dust accumulation.*
- *The case of the air handling units forms a strong structure with specially designed electrostatic coated aluminum profiles and plastic corner fittings. EPDM based gaskets are used for sealing.*
- *Filter selections are made taking into consideration the environment and process requirements of the device.*
- *High efficiency is achieved in coils and filters by preventing leakages that may occur during air flow with special designs.*
- *Depends on request plate type, rotor type or heat-pipe type heat recovery units can be used for energy efficiency which is of great importance nowadays.*
- *The fan-motor group is selected in the most efficient way considering the air flow and total static pressure. Fans can be selected with forward curved blades, backward curved blades and can be driven with belt-pulley or plug types according to the intended use and desired design criteria. Fans are approved with performance tests. The motors are IP55 class as standard and comply with CE norms.*
- *Dampers used in air handling units are manufactured using aluminum profile, aluminum wing and plastic based gears. The gears are outside of the air flow.*

Air Handling Unit Selection Software

Selection and sizing of air handling units and taking a report which has all performance specifications can be easily made with «FKS Selection Software».

With this software all features below can be achieved:

- According to the desired air flow, air velocities in different device sections and serpentine surface can be examined and the most appropriate section can be determined. The desired device can be formed by bringing the specified elements side by side.
- Accessories for each element can be specified.
- In the selection of each element, you can see the brand and model alternatives together with the price rates, efficiency etc. The most suitable one can be selected.
- The maximum size can be determined by how many parts the device will be made up of.
- Dimensions and weights of the parts that make up the device can be seen.
- The technical report containing the price of the selected device, a scaled picture and the necessary information can be printed.

Section and Flow Rates of FKS Series Air Handling Units

Models		Inner Cross-Section		Coil Surface Area	Flow Rate (m ³ /h)								
					Air Velocity at Coil Surface								
		Width (mm)	Height (mm)	m ²	2	2,25	2,5	2,75	3	3,25	3,5	3,75	4
						m/s	m/s	m/s	m/s	m/s	m/s	m/s	m/s
1	FKS 620-465	620	465	0,152	1093	1230	1366	1503	1639	1776	1913	2049	2186
2	FKS 620-620	620	620	0,22	1584	1782	1980	2178	2376	2574	2772	2970	3168
3	FKS 930-620	930	620	0,375	2700	3038	3375	3713	4050	4388	4725	5063	5400
4	FKS 1240-620	1240	620	0,53	3816	4293	4770	5247	5724	6201	6678	7155	7632
5	FKS 930-930	930	930	0,608	4374	4921	5468	6014	6561	7108	7655	8201	8748
6	FKS 1240-930	1240	930	0,859	6182	6955	7727	8500	9273	10046	10818	11591	12364
7	FKS 1550-930	1550	930	1,11	7990	8989	9987	10986	11985	12983	13982	14981	15980
8	FKS 1240-1240	1240	1240	1,187	8548	9616	10685	11753	12822	13890	14959	16027	17096
9	FKS 1550-1240	1550	1240	1,534	11048	12429	13810	15191	16572	17952	19333	20714	22095
10	FKS 1860-1240	1860	1240	1,882	13548	15241	16934	18628	20321	22015	23708	25402	27095
11	FKS 1550-1550	1550	1550	1,959	14106	15869	17632	19395	21158	22921	24685	26448	28211
12	FKS 1860-1550	1860	1550	2,402	17297	19459	21622	23784	25946	28108	30270	32432	34595
13	FKS 2170-1550	2170	1550	2,846	20489	23050	25611	28172	30734	33295	35856	38417	40978
14	FKS 1860-1860	1860	1860	2,923	21047	23678	26309	28940	31571	34201	36832	39463	42094
15	FKS 2170-1860	2170	1860	3,463	24931	28047	31163	34280	37396	40512	43629	46745	49861
16	FKS 2480-1860	2480	1860	4,002	28814	32416	36018	39620	43222	46823	50425	54027	57629
17	FKS 2170-2170	2170	2170	4,08	29372	33044	36716	40387	44059	47730	51402	55073	58745
18	FKS 2480-2170	2480	2170	4,715	33948	38192	42435	46679	50922	55166	59409	63653	67896
19	FKS 2790-2170	2790	2170	5,351	38524	43339	48155	52970	57785	62601	67416	72232	77047
20	FKS 2480-2480	2480	2480	5,428	39082	43967	48852	53737	58622	63508	68393	73278	78163
21	FKS 3100-2170	3100	2170	5,986	43099	48487	53874	59261	64649	70036	75424	80811	86198
22	FKS 2790-2480	2790	2480	6,16	44349	49893	55436	60980	66524	72067	77611	83155	88698
23	FKS 3100-2480	3100	2480	6,891	49617	55819	62021	68223	74425	80627	86829	93031	99233
24	FKS 3410-2480	3410	2480	7,623	54884	61745	68605	75466	82326	89187	96047	102908	109768
25	FKS 4030-2480	4030	2480	9,086	65419	73597	81774	89951	98129	106306	114484	122661	130838
26	FKS 4650-2480	4650	2480	10,549	75954	85449	94943	104437	113931	123426	132920	142414	151908
27	FKS 5270-2480	5270	2480	12,012	86489	97300	108112	118923	129734	140545	151356	162167	172979
28	FKS 5890-2480	5890	2480	13,476	97024	109152	121280	133408	145536	157665	169793	181921	194049

- For air handling units with heater or cooling coil, the air speed selection should be in the range of 2 m/s to 3 m/s.

Practical Air Handling Unit Selection Table

Models		Flow Rate (x1,000 m ³ /h)																					
		1	2	3	4	5	6	7	8	9	10	20	30	40	50	60	80	100	120	140	160	180	
1	FKS 620-465																						
2	FKS 620-620																						
3	FKS 930-620																						
4	FKS 1240-620																						
5	FKS 930-930																						
6	FKS 1240-930																						
7	FKS 1550-930																						
8	FKS 1240-1240																						
9	FKS 1550-1240																						
10	FKS 1860-1240																						
11	FKS 1550-1550																						
12	FKS 1860-1550																						
13	FKS 2170-1550																						
14	FKS 1860-1860																						
15	FKS 2170-1860																						
16	FKS 2480-1860																						
17	FKS 2170-2170																						
18	FKS 2480-2170																						
19	FKS 2790-2170																						
20	FKS 2480-2480																						
21	FKS 3100-2170																						
22	FKS 2790-2480																						
23	FKS 3100-2480																						
24	FKS 3440-2480																						
25	FKS 4030-2480																						
26	FKS 4650-2480																						
27	FKS 5270-2480																						
28	FKS 5890-2480																						

Air Velocity at Coil Surface

2-3 m/s

3-4 m/s

Dimensions of Air Handling Unit Parts

Models	Width	Height	Aspirator & Ventilator			Inlet & Outlet			Coarse Filter	Bag Filter	Carbon Filter	Mixing Cell	Electrical Heater	Heater Water Coil	Heater Steam Coil	Cooler Coil + Drift Eliminator	Steam Humidifier	Evaporative Humidifier	Water Humidifier	Diffuser	Sound Attenuator	Heat Recovery			Vacant Cell												
			Fan Direction			2	3	4														5	6	7		8	9	10	11	12	13	14	15	16	17	18	19
			mm	mm	mm																																
1	FKS 620-465	740	585	930	930	200	500	400	700	700	930	500	300	300	600	600	900	700	350	700-1200	600	930	600	600													
2	FKS 620-620	740	740	930	930	200	500	400	700	700	930	500	300	300	600	600	900	700	350	700-1200	600	930	600	600													
3	FKS 930-620	1050	740	930	930	200	600	400	700	700	930	500	300	300	600	700	900	800	350	700-1200	600	930	600	600													
4	FKS 1240-620	1360	740	1240	1240	200	600	400	700	700	1550	500	300	300	600	700	900	800	350	700-1200	600	1240	600	600													
5	FKS 930-930	1050	1050	1550	1550	300	800	400	700	700	1550	500	300	300	600	700	900	800	350	700-1200	600	1240	600	600													
6	FKS 1240-930	1360	1050	1550	1550	400	800	400	700	700	1550	500	300	300	600	800	900	900	350	700-1200	600	1240	600	600													
7	FKS 1550-930	1670	1050	1550	1550	400	800	400	700	700	1550	500	300	300	600	800	900	900	350	700-1200	600	1550	600	600													
8	FKS 1240-1240	1360	1360	1860	1860	400	800	400	700	700	1550	700	300	300	600	800	900	900	350	700-1200	600	1550	600	600													
9	FKS 1550-1240	1670	1360	1860	1860	500	1000	400	700	700	2170	700	300	300	600	900	900	1000	350	700-1200	600	1860	600	600													
10	FKS 1860-1240	1980	1360	1860	1860	500	1000	400	700	700	2170	700	300	300	600	900	900	1000	350	700-1200	600	2480	600	600													
11	FKS 1550-1550	1670	1670	1860	1860	500	1000	400	700	700	2170	700	300	300	600	900	900	1000	350	700-1200	600	2480	600	600													
12	FKS 1860-1550	1980	1670	1860	1860	500	1000	400	700	700	2170	700	300	300	600	900	900	1000	350	700-1200	600	2480	600	600													
13	FKS 2170-1550	2290	1670	1860	1860	500	1000	400	700	700	2170	700	300	300	600	1000	900	1200	350	700-1200	600	2480	600	600													
14	FKS 1860-1860	1980	1980	2480	2480	500	1200	400	700	700	2170	-	300	300	600	1000	900	1200	350	700-1200	600	3100	600	600													
15	FKS 2170-1860	2290	1980	2480	2480	500	1200	400	700	700	2170	-	300	300	600	1000	900	1200	350	700-1200	600	3100	600	600													
16	FKS 2480-1860	2600	1980	2480	2480	600	1500	400	700	700	2170	-	300	300	600	1000	900	1200	350	700-1200	600	3100	600	600													
17	FKS 2170-2170	2290	2290	2480	2480	600	1500	400	700	700	2170	-	300	300	600	1000	900	1200	350	700-1200	600	3100	600	600													
18	FKS 2480-2170	2600	2290	2480	2480	700	1500	400	700	700	2790	-	300	300	600	1000	900	1200	350	700-1200	600	3100	600	600													
19	FKS 2790-2170	2910	2290	2480	2480	700	1500	400	700	700	2790	-	300	300	600	1000	900	1200	350	700-1200	600	3500	600	600													
20	FKS 2480-2480	2600	2600	2790	2790	900	1500	400	700	700	2790	-	300	300	600	1000	900	1200	350	700-1200	600	3500	600	600													
21	FKS 3100-2170	3220	2290	2790	2790	700	1500	400	700	700	2790	-	300	300	600	1000	900	1200	350	700-1200	600	3500	600	600													
22	FKS 2790-2480	2910	2600	2790	2790	900	1500	400	700	700	2790	-	300	300	600	1000	900	1200	350	700-1200	600	3500	600	600													
23	FKS 3100-2480	3220	2600	2790	2790	900	1500	400	700	700	2790	-	300	300	600	1000	900	1200	350	700-1200	600	3500	600	600													
24	FKS 3410-2480	3530	2600	2790	2790	900	1500	400	700	700	2790	-	300	300	600	1000	900	1200	350	700-1200	600	3500	600	600													
25	FKS 4030-2480	4150	2600	2790	2790	900	1500	400	700	700	2790	-	300	300	600	1000	900	1200	350	700-1200	600	3500	600	600													
26	FKS 4650-2480	4770	2600	3100	3100	900	1500	400	700	700	2790	-	300	300	600	1000	900	1200	350	700-1200	600	3500	600	600													
27	FKS 5270-2480	5390	2600	3100	3100	900	1500	400	700	700	2790	-	300	300	600	1000	900	1200	350	700-1200	600	3500	600	600													
28	FKS 5890-2480	6010	2600	3100	3100	900	1500	400	700	700	2790	-	300	300	600	1000	900	1200	350	700-1200	600	3500	600	600													

Construction of the Air Handling Unit

Specially produced aluminum profiles and panels are used in Air Handling Units.

Electrostatic coated aluminum profiles are resistant to corrosion. Profiles are combined with specially designed plastic corners to each other.

The panels are manufactured in standard sizes, with double skins and rock wool, glass wool or polyurethane are used as insulation material between them. The panel thickness is 50 mm or 60 mm. The outer skin of the panels is made of RAL 9002 color coated with protective polyfilm as standard and the inner skins are made of galvanized, stainless or coated steel. Skin thickness is in 0.8 - 1.2 mm range. The panels are detachable from the outside. Inner surface of air handling units is designed to be completely flat. The panels are mounted directly to the profile with drill-ended screws. EPDM based sealings are adhered between the panels and profiles.

Service doors with sealing are mounted in the necessary places of the air handling unit. According to request and application, service doors can be produced with sight glass. Depending on the size of the device, the base of the Air Handling Unit can be in one piece or divided on the basis of cells. Air handling units are manufactured on a base 150 mm height. There are lifting holes in the base for easy transportation. For outdoor devices, the device is protected from external weather condition with a specially designed roof.

Convenience in Transportation...

In order to provide ease of transportation, the air handling unit can be shipped from cell to cell or shipped disassembled and can be assembled on working area. It is capable of being connected to each other by special connection elements in cell connection. Special EPDM seals are used to seal the joint surfaces.

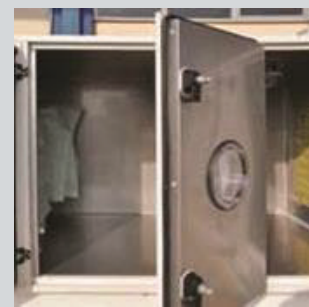

Accessories

Optionally, inside lighting, sight glass, manometer, flexible connection, siphon, maintenance switch, damper motor, rain protection can be used in the air handling units.

Equipments

Filters

The cross-sectional dimensioning of Fantürk Air Handling Units is carried out in accordance with international standards, taking into account the filtration surface area. Filters are cassette type and can be easily installed and removed. Air leaks are prevented by suitable designs. The filter cells have a service door for maintenance and replacement. Optionally manometer, lightning and sight glass can be used. Different types and efficiency filters are used in air handling units considering the importance of indoor air quality.

Filter types in general;

- Panel filter
- Metal filter
- Bag filter
- Activated carbon filter
- Compact filter
- Hepa filter.

Panel filters are used as pre-filters. The filter material is synthetic or metallic. Metal filters feature oil retention. The filter classes we use are; for synthetic material: G2, G3, G4, for metallic material: G2, G3.

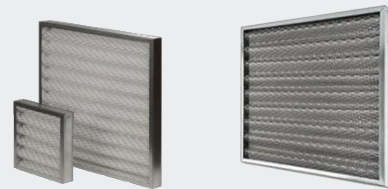

Bag filters are used for high efficiency air filtration. Their dust filtration capacity is high. They should be used together with a pre-filter to increase their service life. Bag length varies according to air flow as 305 mm, 508 mm, 635 mm. The filter classes we use are; G4, F5, F6, F7, F8.



Activated carbon filters are used to absorb foul-smelling gas or vapor molecules in the air (such as exhaust fumes, tire odor, alcohol, hydrocarbon, chlorine, and other chemical production processes). An alternative model is available for the absorption of odors emitted from other industrial processes such as hydrogen sulfide, sulfur dioxide, and should be used in combination with a pre-filter to increase their service life.

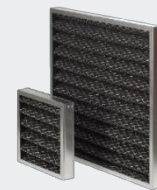

Compact filters are highly efficient filters. They should be used with a pre-filter. Because they are 292 mm deep, they occupy little space in the plant. Due to the filter structure, it is possible to distribute the air evenly over the entire filter surface. The filter classes we use are; F6, F7, F8, F9.

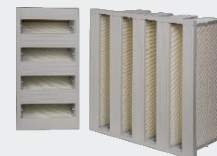

Hepa filters are used for hygienic environments. Their efficiency are very high. These filters are installed after the fan and must be used in combination with a pre-filter. The filter classes we use are; H10, H12, H13, H14.



Equipments

Heat Recovery System

Energy efficiency is great importance nowadays. Therefore, the use of heat recovery units in air handling units has started to be preferred. In Fantürk Air Handling Units, heat pipe, plate and rotor heat recovery elements can be used.

Efficiency in heat recovery systems in general;

- 30-50% in heat pipe type,
- 40-60% in plate type,
- 60-80% in rotary type.

Heat-Pipe Type Heat Recovery Unit

In the heat-pipe type heat recovery units which has a compact structure, heat transfer is occurs by the phase difference due to the temperature difference of the exhaust and fresh air in the closed circuit. No additional equipment is required. There is no mixing of fresh air and exhaust air. Easy to clean and maintain. They are preferred because of their long service life. Heat pipes can be manufactured as corrosion resistant.

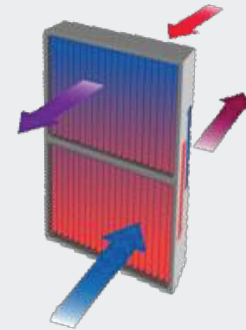
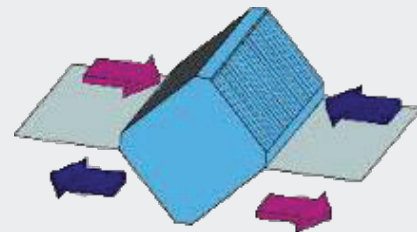

Plate Type Heat Recovery Unit

The cross-flow plate heat recovery elements allow the transfer of heat between fresh air and exhaust air without moving parts. Full sealing is ensured even at high pressure differences. It can operate between -30°C and 90°C . The plates can be made of aluminum, epoxy coated aluminum or stainless steel. They are manufactured with by-pass dampers to prevent freezing for low temperatures. In the exhaust section, a condensate pan is installed to prevent condensation.



Rotor Type Heat Recovery Unit

They have a compact structure and high thermal performance. Heat transfer is carried out with aluminum plates in the appearance of corrugated sheet placed in the rotor. Rotor rotation is provided by belt-pulley driven electric motor. Due to its compact structure, it takes up little space. The heat efficiency of the rotors is optimized for a 12 rpm rotation speed. Can be increased according to application situation. If capacity control is required according to variable climatic conditions, speed control is performed with frequency converter. Request for capacity control is required in order. There is no risk of freezing.

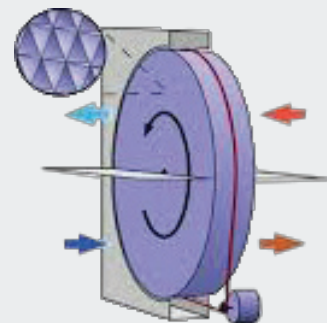

Equipments

Electrical Heater

Fantürk Air Handling Units can be equipped with electric heater upon request. It is used in the entrance of the device in areas with high risk of freezing. In addition, it is used at the exit of the plant in sensitive systems that require sudden heating. The electric heater cassette is made of galvanized or stainless material upon request. The elements are stainless material. Protection class is IP43. Gradual or proportional control can be made. It has CE certificate. As standard, heaters are equipped with automatic reset limit thermostat and manual reset safety thermostat. If the heater power is above 30 kW, it is recommended to operate the air handling unit's fan for 2-3 minutes after the electrical heater is de-energized. If there is an electric heater in the air handling unit, it is absolutely necessary to take precautions to turn the electric heater off in cases where the fan does not work or it operates at very low speeds (below 1.5 m / s).



Heater or Cooler Coil

Heating and cooling operations are carried out with coils. The coil pipes may be copper or steel, blades may be aluminum, copper, steel, epoxy coated aluminum or epoxy coated copper. Direct expansion coils are manufactured as copper pipe-aluminum fins and collectors are made of copper. The serpentine cassette is made of galvanized steel. The test pressure is 20 bar. In hot and cold water coils, pipe inlet and outlet openings are threaded; In hot water and steam coils, pipe inlet and outlet openings are flanged. Designed to be easily removed for maintenance. Special bypass sheets allow air to pass only through the coil surface. It is designed with reverse flow of air and water for high efficiency. In hot and cold water coils, the water inlet is from the bottom and the water outlet is from the top. In the cooling coils, the surface area of the coil is efficiently used thanks to the condensation pan installed in the panel. Condensate pan is made of stainless steel with double slope. After the cooling coil, a separator is used to separate the condensed water in the air.



DX Coil

DX Coils minimize heat and energy loss by means of direct heat transfer from the air through refrigerant. At low temperatures in winter, it is necessary to use an electric or water preheater or a freezing thermostat. Outdoor unit connections can be made easily. Maintenance and repair is very simple.



Equipments

Rotor & Motor

Various fan types are available in each section in accordance with air flow and total pressure drop. Statically and dynamically balanced fans in accordance with international standards can be forward-curved, back-curved or airfoil blades depending on the intended use and customer requirements. Fan-motor group is selected considering high efficiency, low noise level and minimum energy consumption depending on air flow and total static pressure. In order to prevent vibration, the fan-motor group is connected to the device with spring insulators.

Standard bushed, fixed diameter pulleys are used as standard in our devices and it is possible to use variable diameter pulleys as an option. SPZ, SPA, SPB and SPC belt types are available. The belt is tensioned by a special mechanism.

The fan cell has a service door with safety guard for service and maintenance. In special cases, plug type fans are used and the motor is directly coupled.

The motors are IP55 protection class as standard and comply with CE norms. The motors are single speed as standard and double speed motors can be used as an option. A frequency converter for motor speed control is available as an accessory.

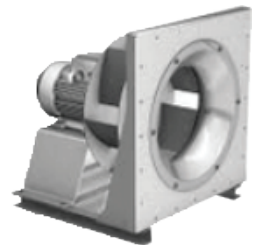

Diffuser

Diffusers are used after the fan to ensure homogeneous distribution of air on the elements such as filters, coils, sound attenuator.





Sound Attenuator

The noise level, which is of great importance in ventilation systems, is reduced to acceptable sound level by means of attenuators. The sound absorption coefficient of the attenuators varies according to the size of the attenuator used. The attenuator cell consists of backstands with rock wool in galvanized or stainless steel. The attenuator elements are designed so that they do not deform at an air velocity of 20 m/s. 6 different attenuator sizes are offered in Fantürk Air Handling Units. The following tables show the sound absorption capacities according to the size of the muffler.

Length of Attenuator (mm)	Sound Absorption Capacity (dB)							
	63 Hz	125 Hz	250 Hz	500 Hz	1000 Hz	2000 Hz	4000 Hz	8000 Hz
600	5	9	15	16	16	11	8	8
900	6	12	21	22	23	16	11	11
1200	7	15	27	28	29	20	12	12
1500	9	19	33	34	36	25	17	17
1800	10	22	39	40	42	29	20	20
2100	11	25	45	46	48	33	23	23

Control Functions

Function - Equipment	Explanation	Standard-S Optional-O
Emergency Stop Button	Emergency stop button that stops the system in case of emergency	O
Terminal board for external cable connections	Motor terminal blocks are moved to an easily accessible panel outside the device	S
<p>AUTOMATIC CONTROL</p> <p>Electronic control panel Duct type temperature sensor Duct type humidity sensor Valve actuators Damper servomotors Frequency converters</p>	<p>Air temperature control at desired points or contacts. Humidity control at the desired point (s). Control of two-way or three-way valves. Control of dampers. Air pressure control.</p>	<p>O O O O O</p>
<p>MICROPROCESSOR CONTROL</p> <p>Microprocessor Duct type temperature sensors Duct type humidity sensors Differential pressure probes Valve actuators Damper servomotors Frequency converters</p>  	<ul style="list-style-type: none"> -Air flow is controlled. Pressure control can be made between two spaces. Generating alarm information if desired flow rate is not achieved (clogging, failure, contamination). -Adjustment of desired fan flow rate according to working altitude and temperature. -Pre-heating, heating, and cooling algorithms can optionally be made according to input, output or preheat temperatures. Ventilation temperature limit control can be done. -Detection of pollution of all filters used separately and generating alarm information. -DX Battery control provides efficient working conditions. -To see all the parameters, it is possible to change the terminal. -All devices can communicate in the form of a network. -Operation and configuration parameters can be encrypted. -Voice and visual alarm information can be given. -Daily, weekly work-stop time adjustment can be made. -Turkish, English languages can be used as desired. -All system can be connected to a central computer with additional hardware, managed and accessible via internet. -When the device configuration is changed, the new configuration can be defined parametrically. (addition of humidifier, valve-damper control changes, dehumidification, changing the fan control pattern, etc.) -The temperature control can be done as parametric proportional, proportional + integral or proportional + integral+ derivative. -Compensations can be made according to the outside air temperature and can be adjusted parametrically. -The control of the fans can be done parametrically, thermostatic, continuous, gradual or proportional. -The starting mode of fan motors (pole, star, triangle) can be set parametric. -Each equipment can be tested individually. -All kinds of alarm information is kept in memory (Differential pressure switches, thermal, sensor, emergency stop etc.) -All additional communication languages (Modbus, BACnet, Lon-ECHOLON, LAN TCP / IP, SNMP) can be integrated with the building automation system. 	<p>O</p>

fanturkey HVAC Expert

Contact Information:

*Address: Minareliçavuş OSB Mah. 202. Sk. N:19 Nilüfer / BURSA /
TURKEY*

Export & International Operations Manager:

Mr. Aslan TEKİN

Mobile: +90 552 616 40 57 (WhatsApp, Viber, Telegram)

Group Mail: export@fanturkey.com

Ukraine Representative:

Mr. Soshenko Konstantin

Mobile: +380 685 83 50 31 (WhatsApp, Viber, Telegram)

fanturkey.com