

**J-FWA**  
**Axial Jet Fan**

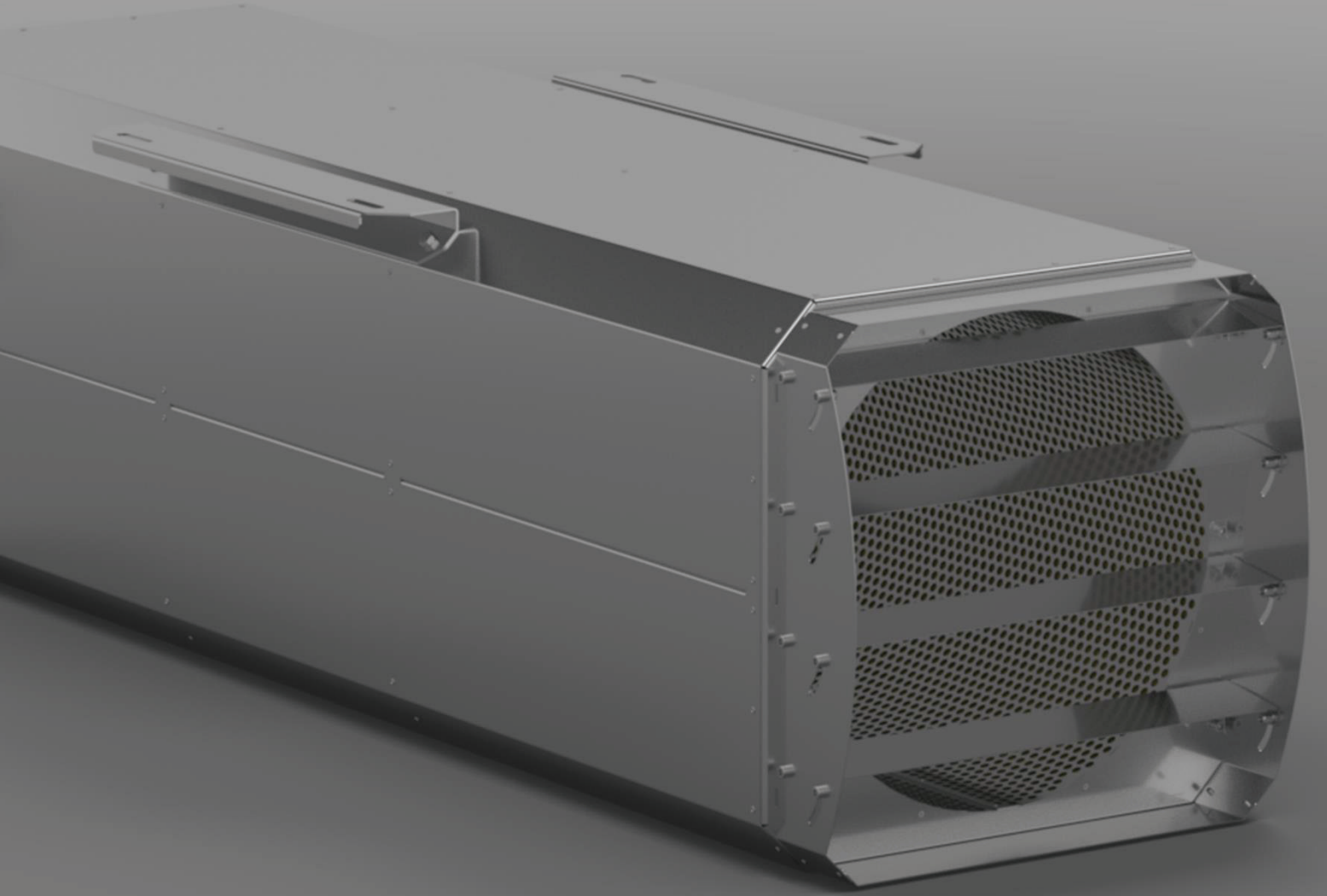

## General Features

*The products have fire-resistant certificate and tested for working for 2 hours at 400 °C in international accredited organizations according to EN 12101-3 standard.*

*It is manufactured between Ø315mm and Ø630mm diameters.*

*According to the project, uni-directional or reversible and two-speed or single-speed options are available.*

### **Fan Body**

*J-FWA Axial Jet Fan models are manufactured from high quality galvanized steel.*

### **Propeller**

*The propellers are made of special aluminum alloy with adjustable blade angles. According to the project, it can operate in the same performance in both blowing directions thanks to its reversible blade structure. Complies with international standards.*

### **Motor**

*It is manufactured as standard (380 V - 50 Hz) or other voltages and frequencies (400/415/440 V - 50 Hz) on request. As a standard, Class H, S1+S2, IP55 single-speed or double-speed motors with a resistance of 2 hours to 400 degrees are used.*

### **Accessories**

*In this series, the sound volume increases due to the high air outlet velocities and therefore jet fans are used as standard with the silencer.*

### **Sliding System**

*Thanks to its unique sliding system design, disassembly or maintenance time is minimized with easy intervention to the motor*

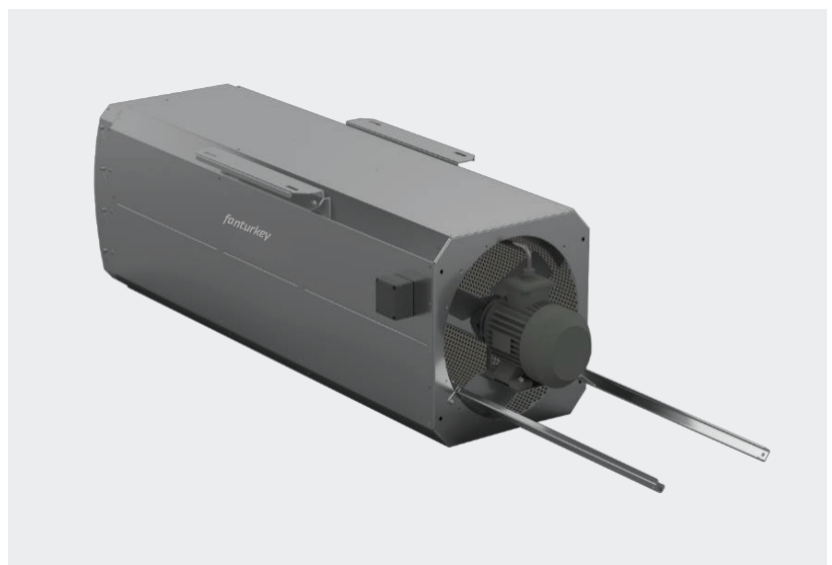

## Technical Specifications

# AXIAL JET FAN

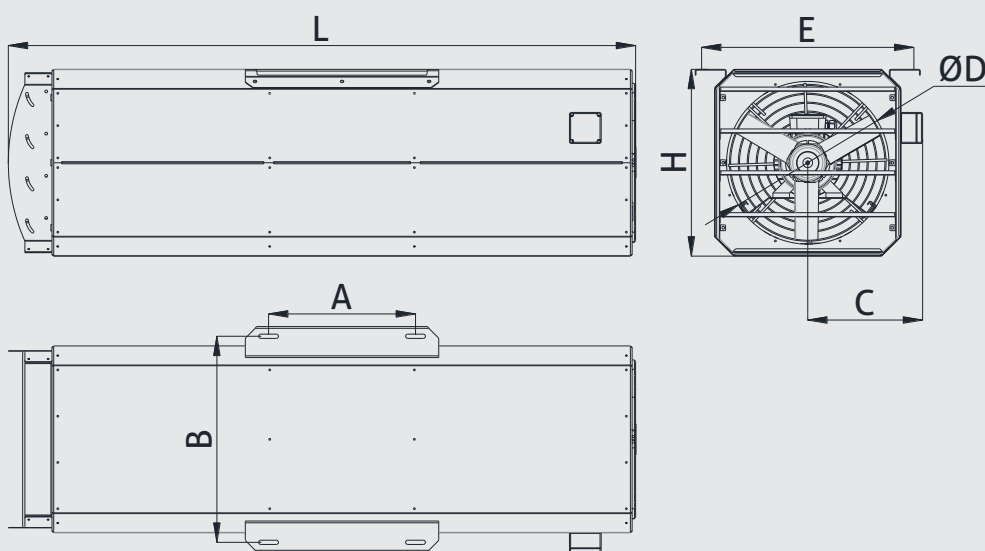
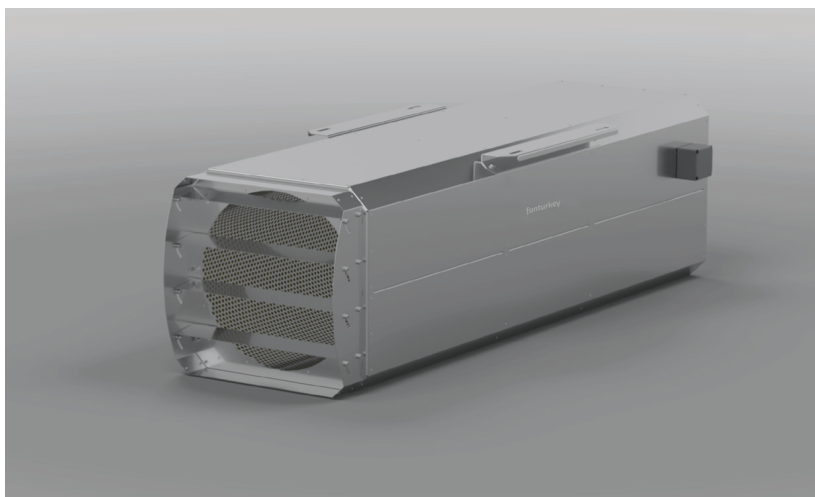

MODEL	A	B	C	D	E	H	L	THRUST	MAX. FLOW RATE	MOTOR POWER	MOTOR SPEED	MAX. AIR VELOCITY	SOUND PRESSURE LEVEL	WEIGHT
	mm	mm	mm	mm	mm	mm	mm	N	m <sup>3</sup> /h	kW	rpm	m/s	dBa	kg
J-FWA 315	380	445	250	335	495	395	1615	24	4500	0,75/0,17	3000/1500	16	69/54	65
J-FWA 355	380	485	270	375	535	435	1625	40	6500	1/0,25	3000/1500	18	74/59	85
J-FWA 400	380	530	290	420	580	480	1635	60	9000	1,3/0,33	3000/1500	20	75/60	100
J-FWA 450	380	580	320	470	630	530	1845	85	12000	2/0,5	3000/1500	21	82/67	140
J-FWA 500	380	630	340	520	680	580	2060	150	17500	3,6/0,9	3000/1500	25	90/75	170
J-FWA 560	380	690	370	580	740	640	2180	235	24000	6,5/1,7	3000/1500	28	91/76	230

## Automation Panel and Control System

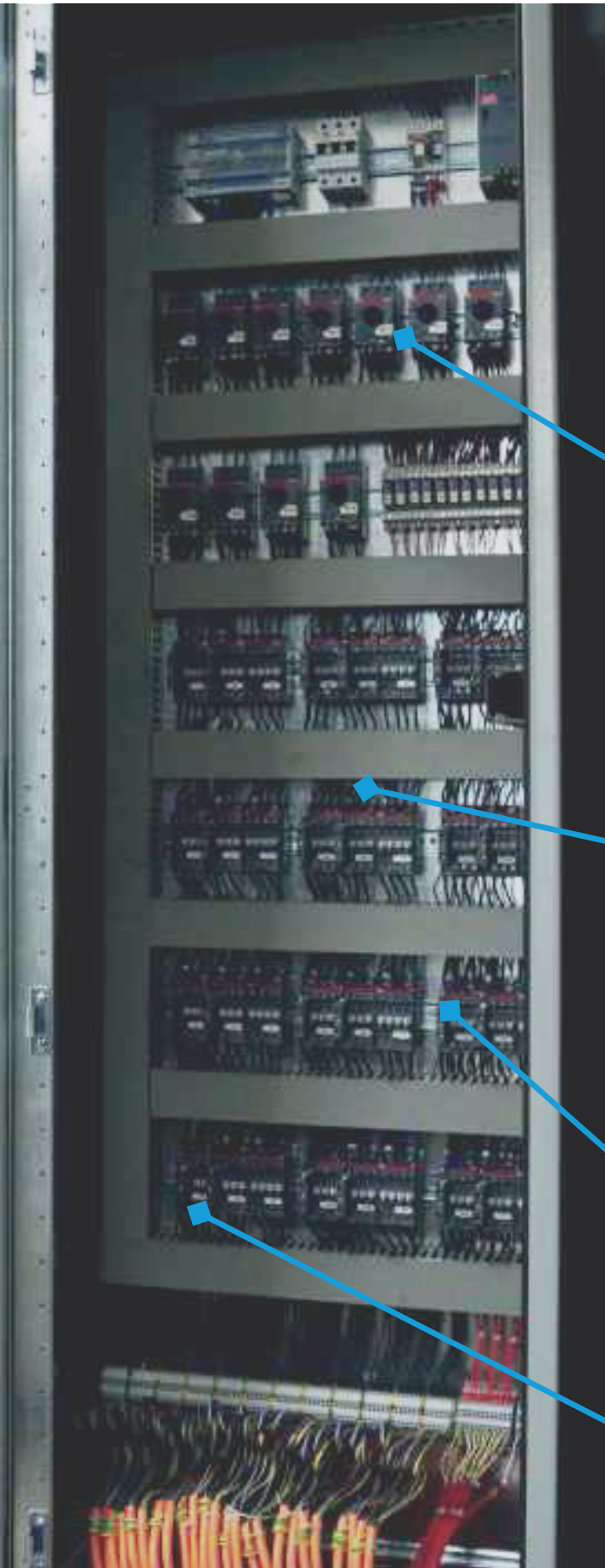

Automation panel is responsible for operating in accordance with the ventilation scenarios processed. PLC (Programmable Logic Card) which is carried by all mechanical devices (axial fans, jet fans, air / smoke dampers, doors etc.) in the system according to the signals coming from the carbon monoxide detection system and / or fire / smoke detection system which analyzes the situation in the parking lot.

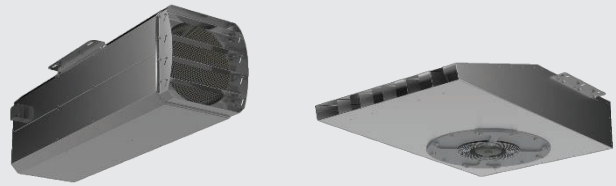

Jet fans operate at 1. Motor Speed for daily ventilation according to the signals from the gas sensors or 2. Motor Speed according to the signals from the fire / smoke detection system.

Floor dampers are closed and opened according to the scenario written in order to prevent harmful gas and smoke from reaching the other floors in case of fire.



Fresh air and smoke exhaust fans are activated according to the signals from the gas and fire / smoke detection systems and exhaust of harmful gas is provided.

It works fully compatible with gas sensors and smoke / fire detection systems used in the parking lot.



# CFD Analysis

Car park ventilation projects with jet fans should be supported by computational fluid dynamics analysis. The CFD analysis is very important for the accuracy of the project work, the precise determination of the jet fan locations, and the control of the position of the exhaust and fresh air shafts.

After the 3D modeling of the car park, the analysis should be prepared with fire simulation and boundary conditions prepared in accordance with BS 7346-7 standard. The situation of the car park in case of a possible fire or evacuation of the exhaust gases formed in the building is examined with this simulation.

This provides preliminary information on how the air flow and smoke evacuation will actually behave.

These analyzes should be performed by CFX, Flow Simulation, PyroSim or similar internationally recognized software. The number and layout of the jet fans should be optimized according to the simulation result.

## By CFD Analysis;

- 1.7m above ground density, visibility and air movement
- Temperature distribution in the parking lot in case of fire,
- Details of the air flow in the parking lot,
- Air velocity profiles are examined.

**Smoke Analysis**

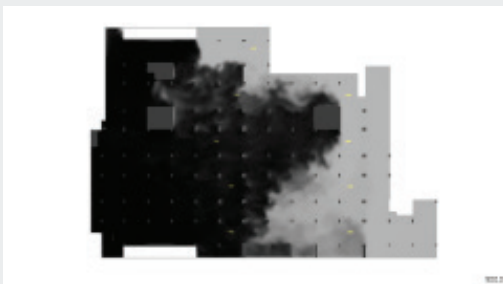

**Visibility Range Analysis**

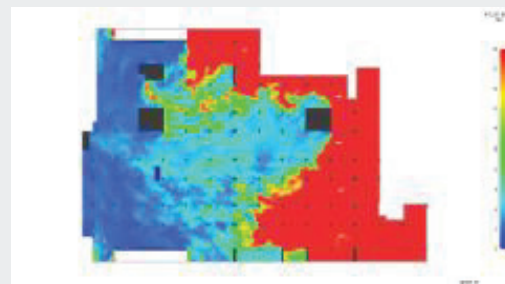

**Air Velocity Analysis**

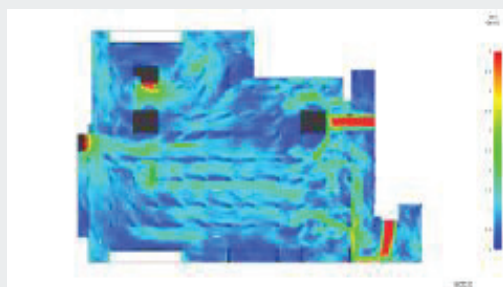

**Temperature Analysis**

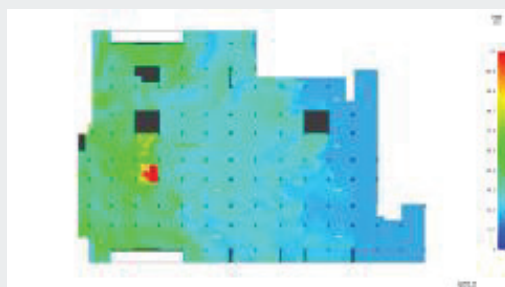

The analyzes are performed according to ASHRAE, BS 7346-7, NFPA 130 standards.

# *fanturkey* HVAC Expert

## *Contact Information:*

*Address: Minareliçavuş OSB Mah. 202. Sk. N:19 Nilüfer / BURSA /  
TURKEY*

## *Export & International Operations Manager:*

*Mr. Aslan TEKİN*

*Mobile: +90 552 616 40 57 (WhatsApp, Viber, Telegram)*

*Group Mail: [export@fanturkey.com](mailto:export@fanturkey.com)*

## *Ukraine Representative:*

*Mr. Soshenko Konstantin*

*Mobile: +380 685 83 50 31 (WhatsApp, Viber, Telegram)*

*[fanturkey.com](http://fanturkey.com)*