

fanturkey
HVAC Expert

M-HA
Cabinet Type
Kitchen Aspirator
with Metal Filter



fanturkey.com

Technical Specifications

CABINET TYPE KITCHEN ASPIRATOR

M-HA series kitchen aspirators are the ideal devices to clean exhaust air taken from kitchens or cooker hoods. With G2 metal filter at the entrance and optionally electrostatic filter, cylindrical activated carbon filter, UV filter, it keeps the oil and soot particles in the suction air and clean the air to be thrown into the atmosphere.

Cabinet panels has isolated with 50mm thickness of rock wool. Inner skin is made of high quality corrosion-resistand galvanized steel. Outer skin is made of coated steel. The fans are radial fans with backward curved blades. To cover motor from oily and hot air, it is enclosed in a seperate cell that has not affected from air flow. This increases the service life of the device and eliminates the risk of fire.

Usage Areas

In industrial kitchens, restaurants, hotels, shopping centers, cooking areas, it is used to exhaust hot, oily air that emerges during cooking.

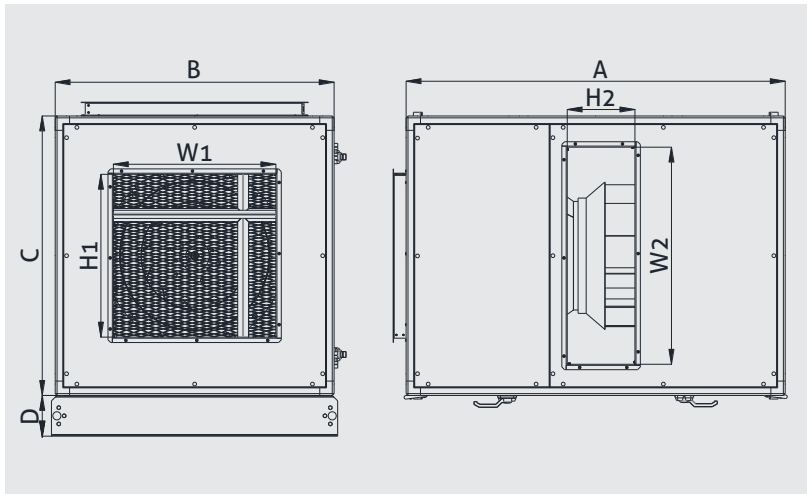
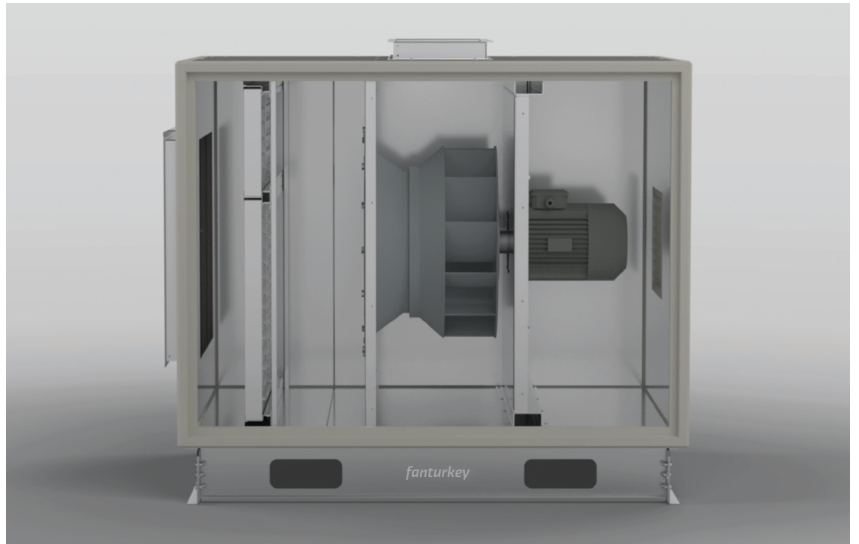

MODEL	A	B	C	D	Inlet W1xH1	Outlet W2xH2	FLOW RATE	VOLTAGE	FREQUENCY	MOTOR POWER	CURRENT	MOTOR SPEED	WEIGHT
	mm	mm	mm	mm	mm	mm	m ³ /h	V	Hz	kW	A	rpm	kg
M-HA 250	1050	720	720	150	400x400	350x200	3000	380	50	0,37	1,2	1360	115
M-HA 280	1050	720	720	150	400x400	350x200	5000	380	50	0,55	1,6	1370	128
M-HA 315	1300	1030	720	150	600x450	600x200	7500	380	50	1,1	2,6	1390	180
M-HA 355	1400	1030	1030	150	600x600	800x250	10000	380	50	2,2	5,2	1420	235
M-HA 400	1400	1030	1030	150	600x600	800x250	15000	380	50	4	8,2	1430	260
M-HA 450 A	1710	1340	1340	150	1280x800	900x400	17500	380	50	5,5	11,2	1440	385
M-HA 450 B	1710	1340	1340	150	1280x800	900x400	20000	380	50	7,5	15,4	1450	400

Performance Curves

M-HA 250

Voltage 380 V
Frequency 50 Hz
Motor Power 0,37 kW
Motor Speed 1360 rpm
Weight 115 kg

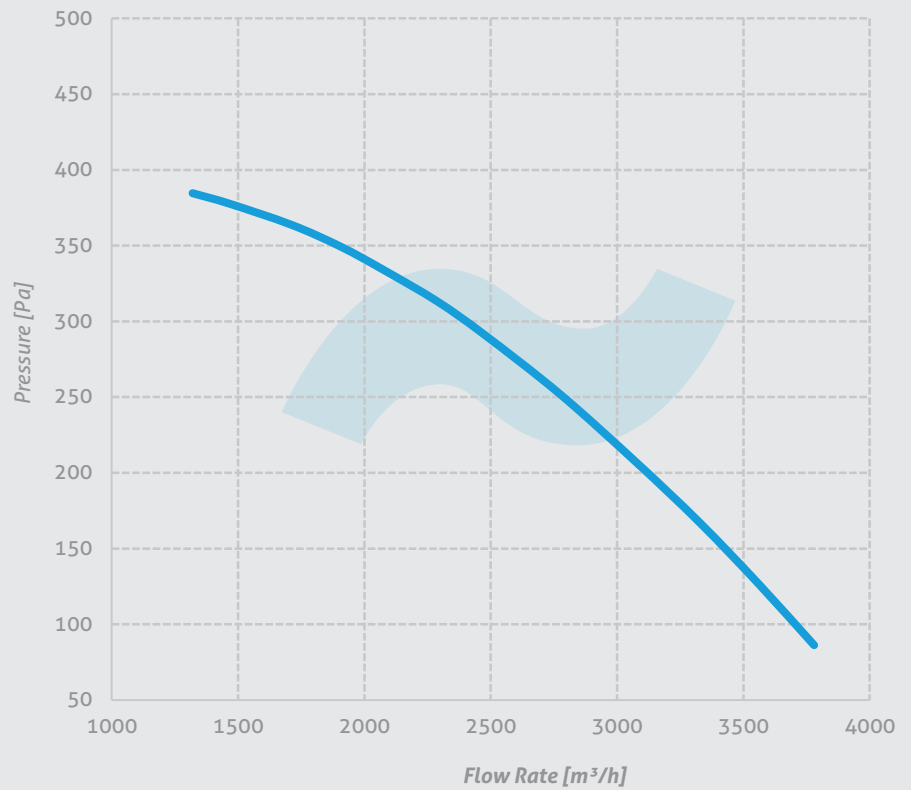

M-HA 280

Voltage 380 V
Frequency 50 Hz
Motor Power 0,55 kW
Motor Speed 1370 rpm
Weight 128 kg

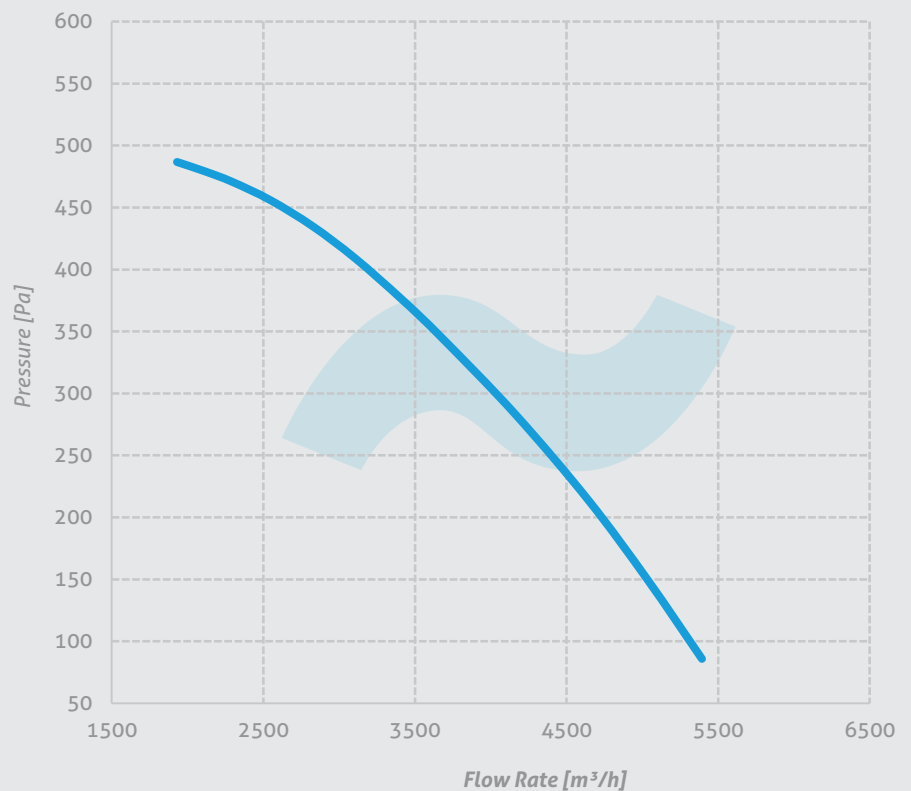

Performance Curves

M-HA 315

Voltage 380 V
Frequency 50 Hz
Motor Power 1,1 kW
Motor Speed 1390 rpm
Weight 180 kg

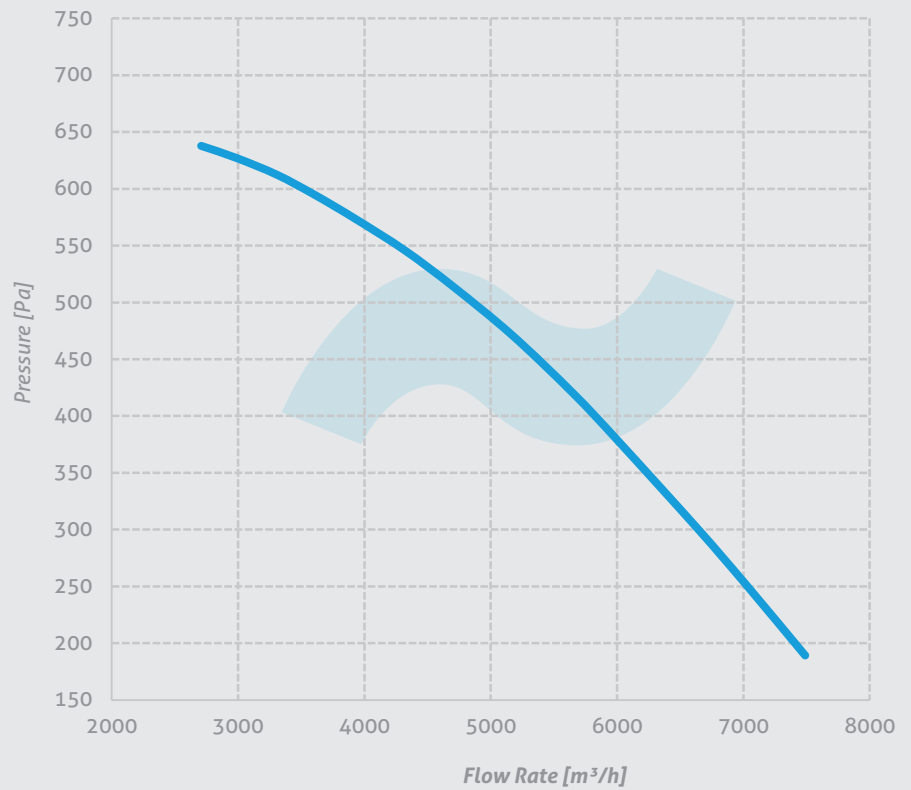

M-HA 355

Voltage 380 V
Frequency 50 Hz
Motor Power 2,2 kW
Motor Speed 1420 rpm
Weight 235 kg

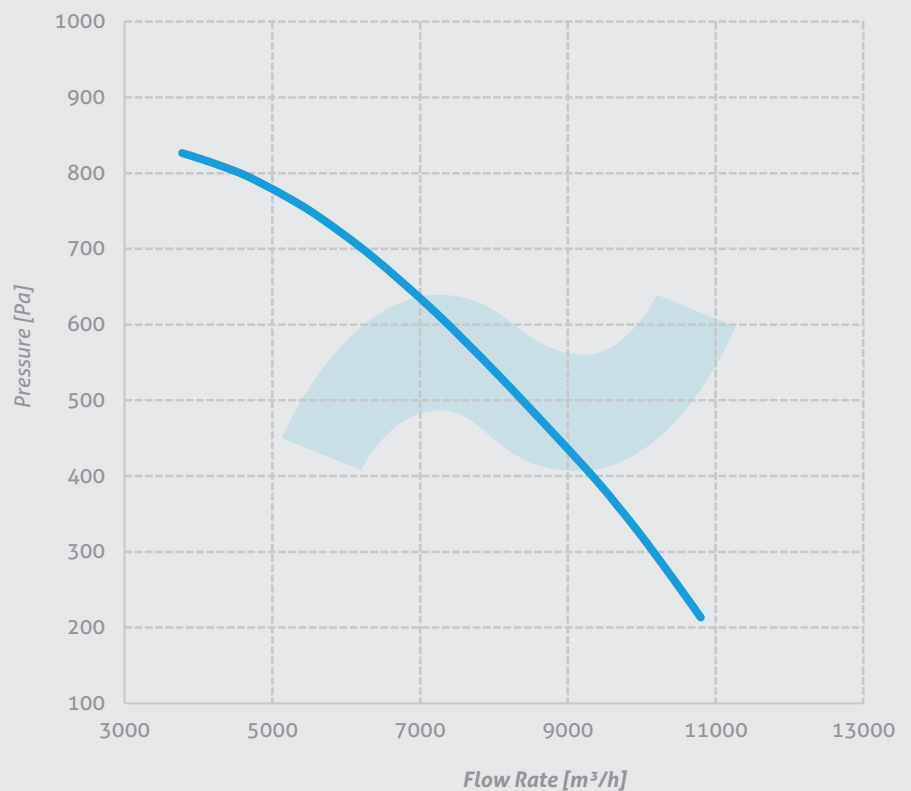

Performance Curves

M-HA 400

Voltage 380 V
Frequency 50 Hz
Motor Power 4 kW
Motor Speed 1430 rpm
Weight 260 kg

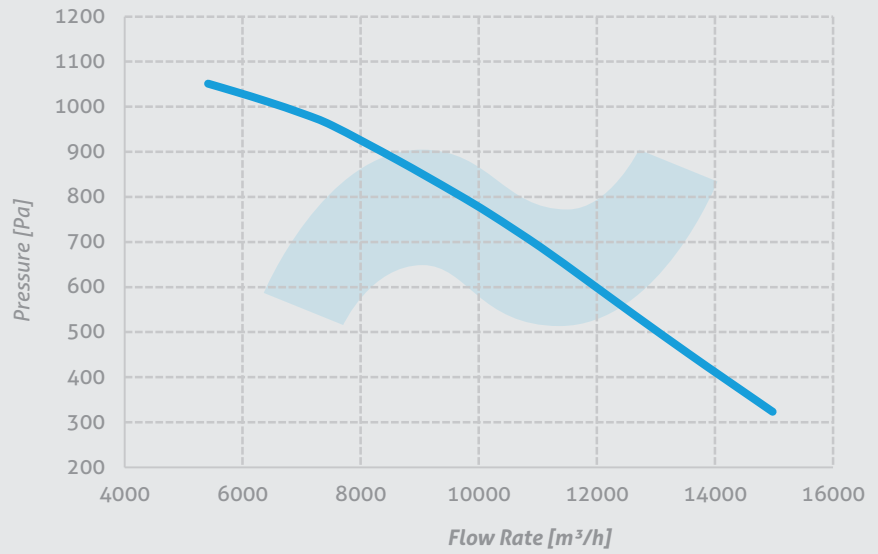

M-HA 450 A

Voltage 380 V
Frequency 50 Hz
Motor Power 5,5 kW
Motor Speed 1440 rpm
Weight 385 kg

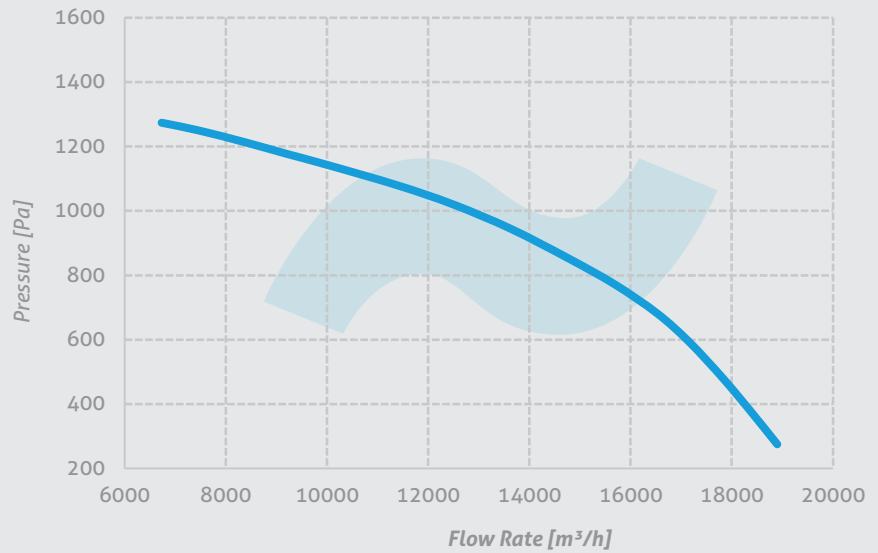

M-HA 450 B

Voltage 380 V
Frequency 50 Hz
Motor Power 7,5 kW
Motor Speed 1450 rpm
Weight 450 kg

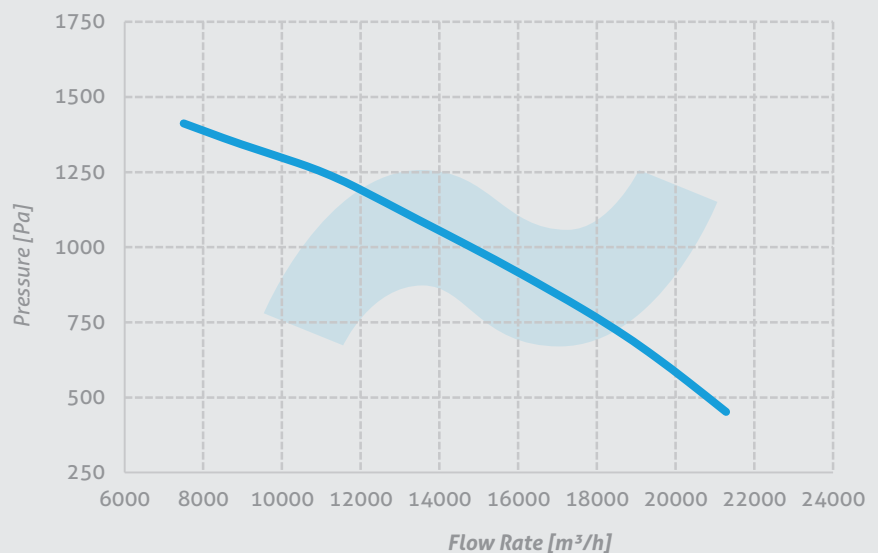

fanturkey HVAC Expert

Contact Information:

*Address: Minareliçavuş OSB Mah. 202. Sk. N:19 Nilüfer / BURSA /
TURKEY*

Export & International Operations Manager:

Mr. Aslan TEKİN

Mobile: +90 552 616 40 57 (WhatsApp, Viber, Telegram)

Group Mail: export@fanturkey.com

Ukraine Representative:

Mr. Soshenko Konstantin

Mobile: +380 685 83 50 31 (WhatsApp, Viber, Telegram)

fanturkey.com