

fanturkey
HVAC Expert

P-FWA
Axial
Fresh Air Fan

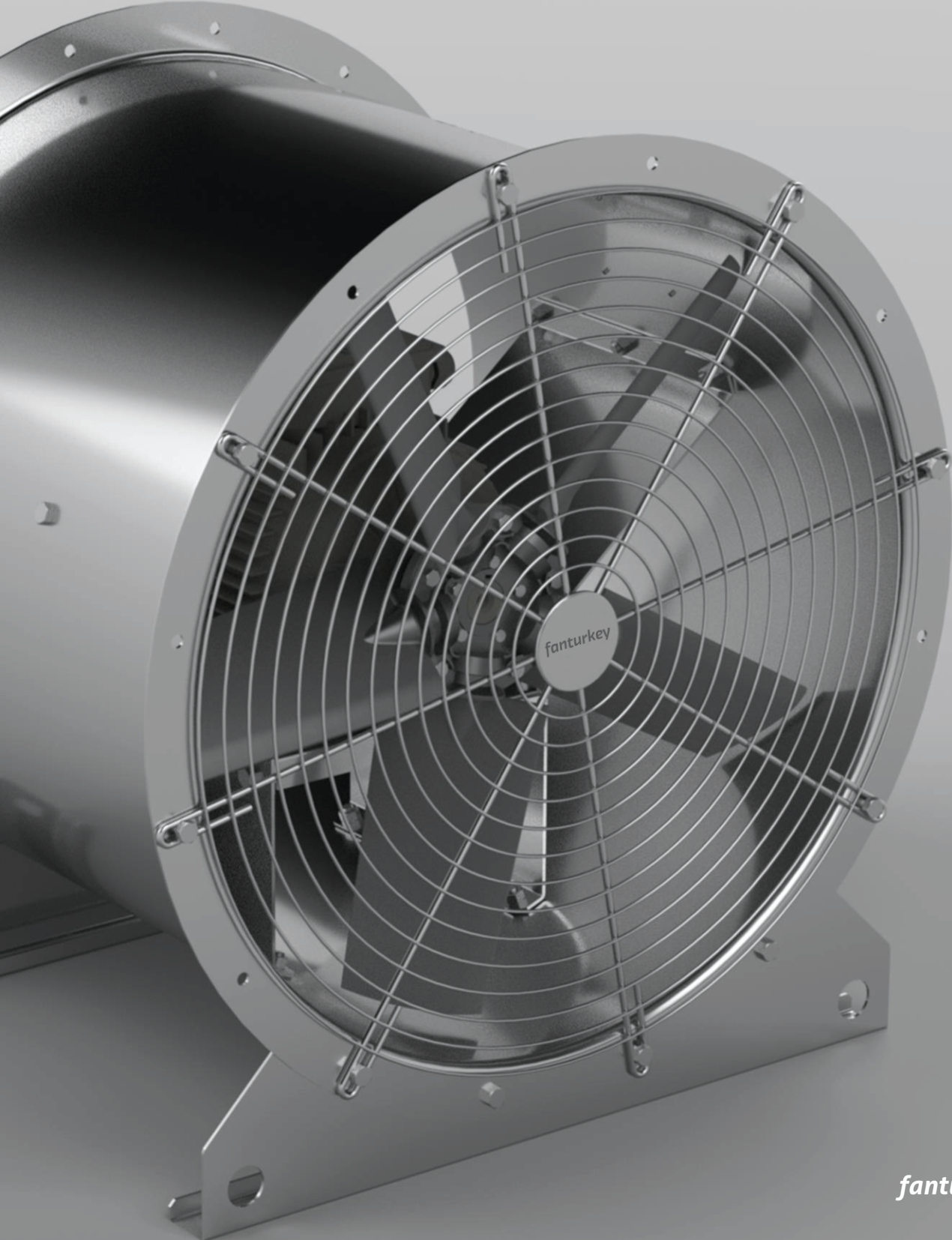

fanturkey.com

Technical Specifications

AXIAL FRESH AIR FAN

P-FWA series axial fresh air fans are the ideal fans to meet the fresh air requirement in ventilation systems where high air flow is required. Thanks to their compact construction, they can be installed directly in air ducts, shaft, roof floor, any position required. P-FWA axial fans have high performance, trouble-free operation.

It is manufactured between Ø400mm and Ø1250mm diameters. The body is made of high quality, corrosion-resistant galvanized steel. The propellers are made of special aluminum alloy with adjustable blade angles. According to the project, uni-directional or reversible options are available. It is manufactured as standard (380 V - 50 Hz) or other voltages and frequencies (400/415/440 V - 50 Hz) on request. Motors can be single-speed or double speed and have Class H, S1, IP55 insulation. The sound level can be controlled by adding a silencer at the sensitive points.

Optionally, it can be manufactured with Ex-Proof feature.

Usage Areas

Can be used in all kinds of industrial, office, shopping mall, hospital, parking and residential ventilation to meet the fresh air requirement.

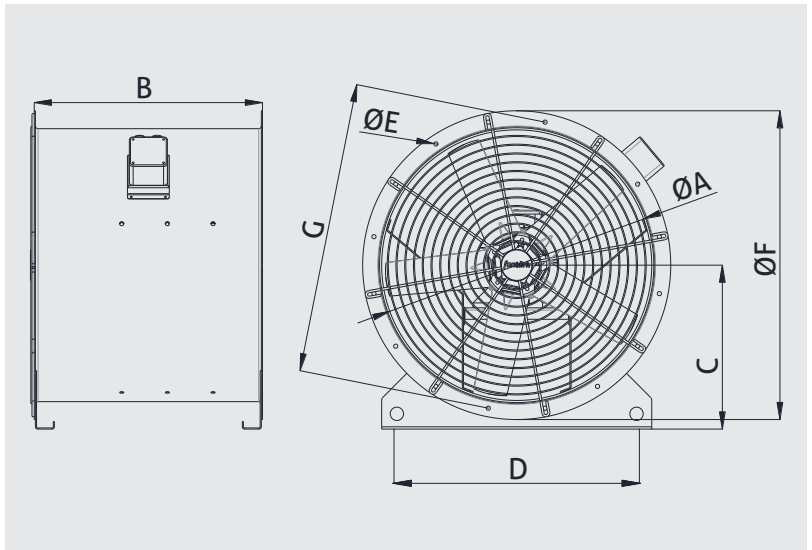

	A	B	C	D	E	F	G	VOLTAGE	FREQUENCY
MODEL	mm	mm	mm	mm	mm	mm	mm	V	Hz
P-FWA 400	400	500	275	335	Ø9x8	500	450	380	50
P-FWA 450	450	500	300	385	Ø9x8	550	500	380	50
P-FWA 500	500	600	325	435	Ø9x8	600	550	380	50
P-FWA 560	560	600	355	495	Ø9x8	660	610	380	50
P-FWA 630	630	600	390	565	Ø9x8	730	680	380	50
P-FWA 710	710	600	430	645	Ø11x16	810	760	380	50
P-FWA 800	800	600	475	735	Ø11x16	900	850	380	50
P-FWA 900	900	750	525	735	Ø11x16	1000	950	380	50
P-FWA 1000	1000	800	595	835	Ø11x16	1100	1050	380	50
P-FWA 1120	1120	1000	655	935	Ø11x16	1220	1170	380	50
P-FWA 1250	1250	1000	720	1035	Ø11x16	1330	1280	380	50

Performance Curves

P-FWA 400

Nos. of Blades 3
 Hub Size 6
 Pitch Angle 45°
 Nos. of Poles 2
 Material Aluminum

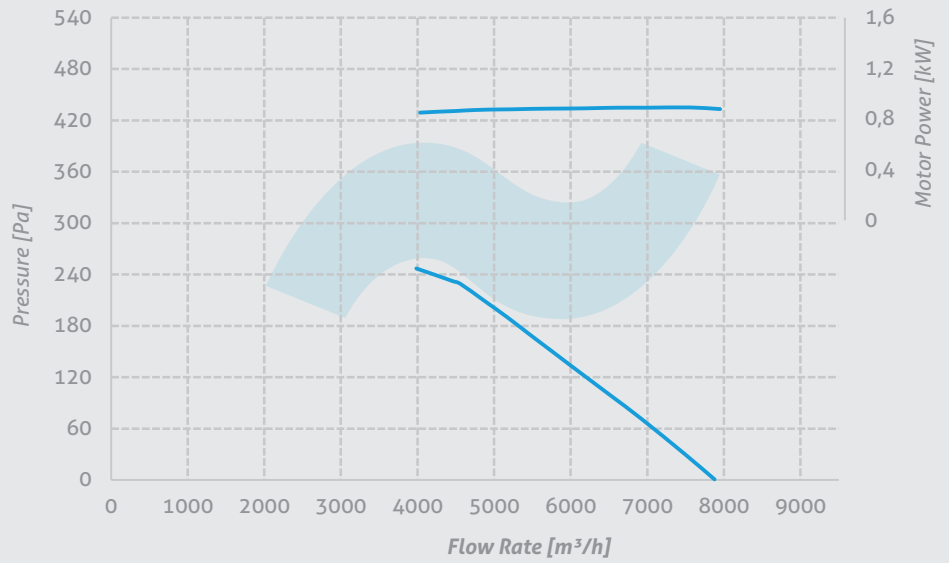

P-FWA 400

Nos. of Blades 3
 Hub Size 6
 Pitch Angle 45°
 Nos. of Poles 4
 Material Aluminum

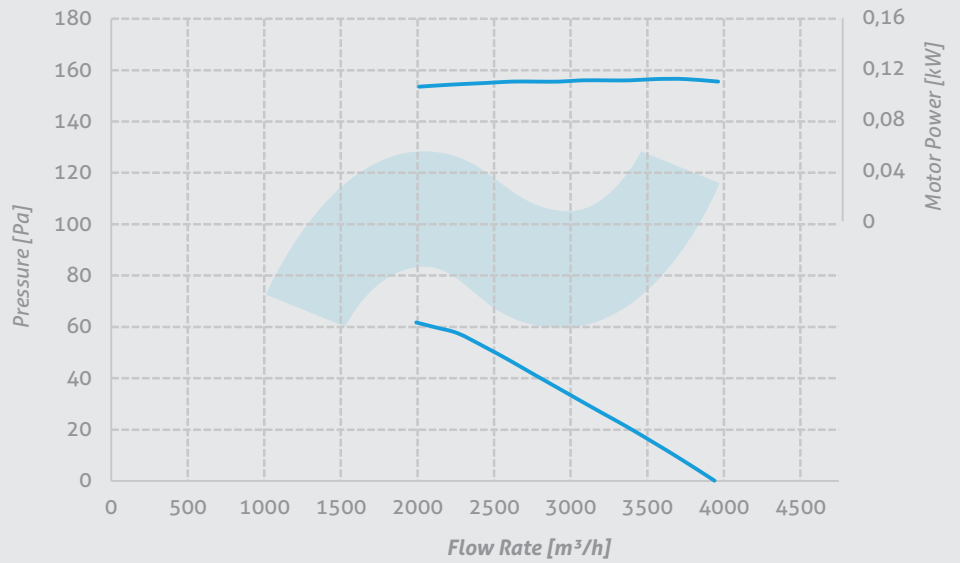

P-FWA 400

Nos. of Blades 3
 Hub Size 6
 Pitch Angle 45°
 Nos. of Poles 6
 Material Aluminum

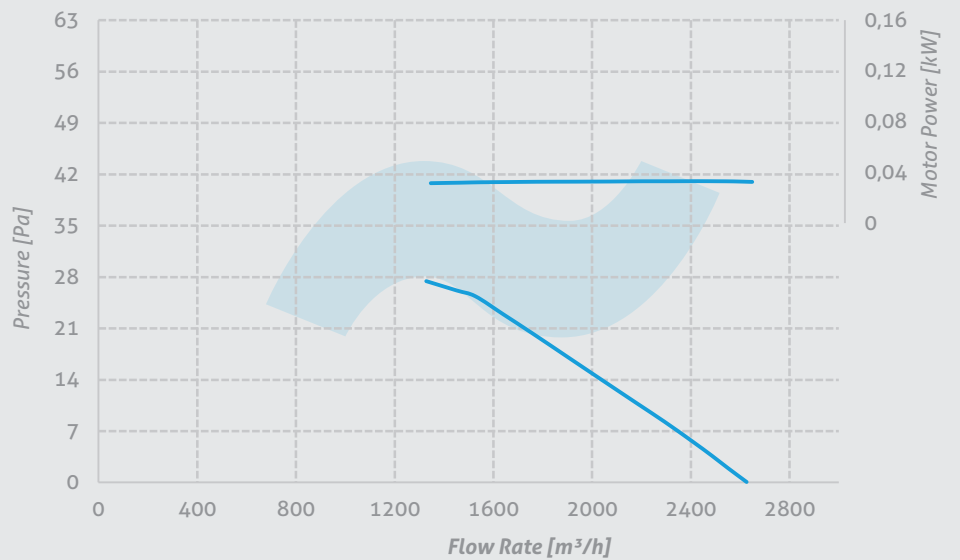

Performance Curves

P-FWA 400

Nos. of Blades 6
Hub Size 6
Pitch Angle 45°
Nos. of Poles 2
Material Aluminum

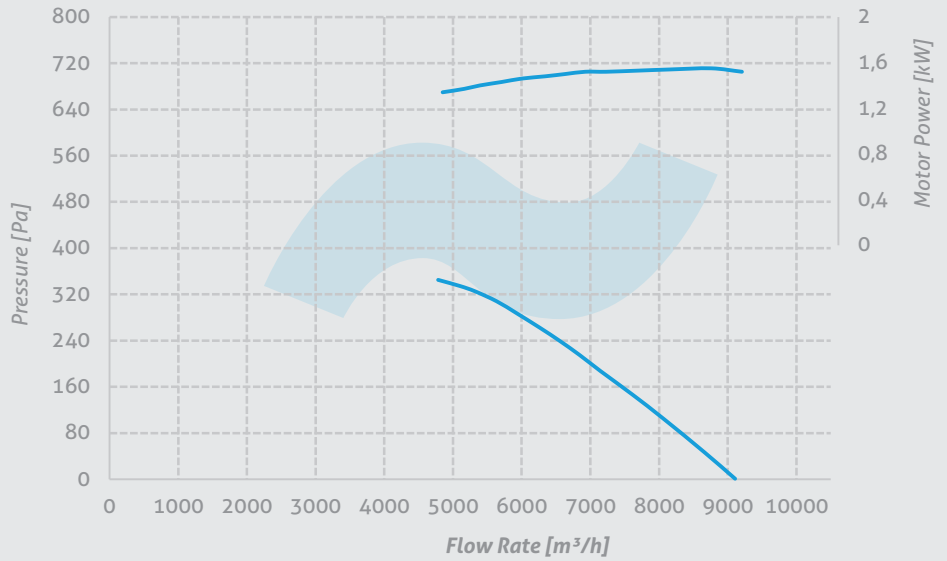

P-FWA 400

Nos. of Blades 6
Hub Size 6
Pitch Angle 45°
Nos. of Poles 4
Material Aluminum

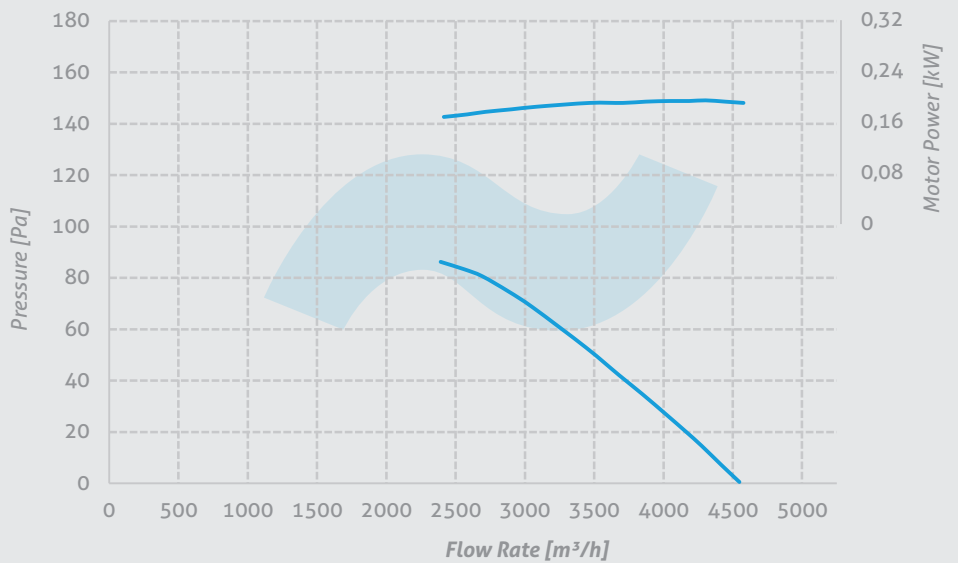

P-FWA 400

Nos. of Blades 6
Hub Size 6
Pitch Angle 45°
Nos. of Poles 6
Material Aluminum

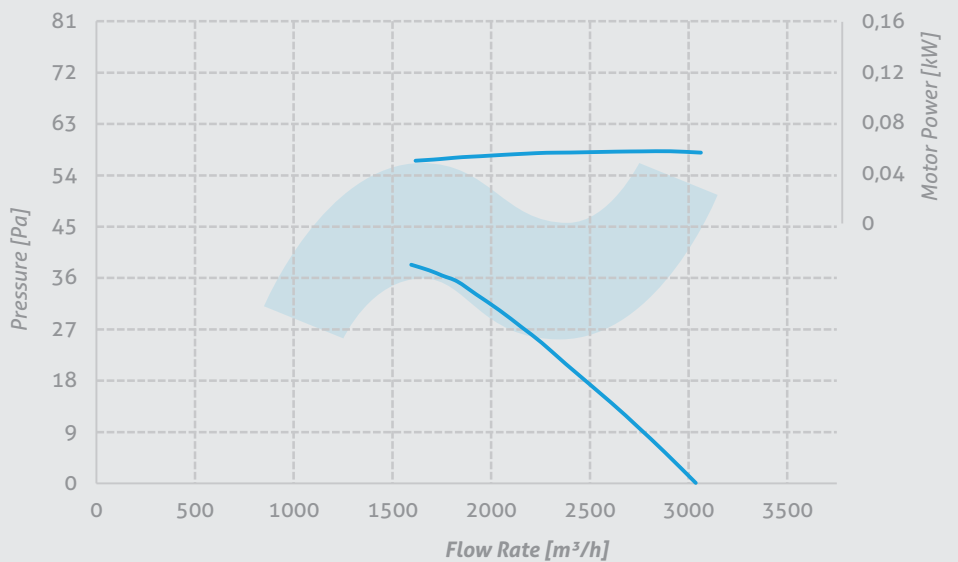

Performance Curves

P-FWA 400

Nos. of Blades 5
 Hub Size 5
 Nos. of Poles 2
 Material Aluminum
 Pitch Angle

- 25° 30° 32,5°
- 35° 37,5° 40°
- 45° 50°

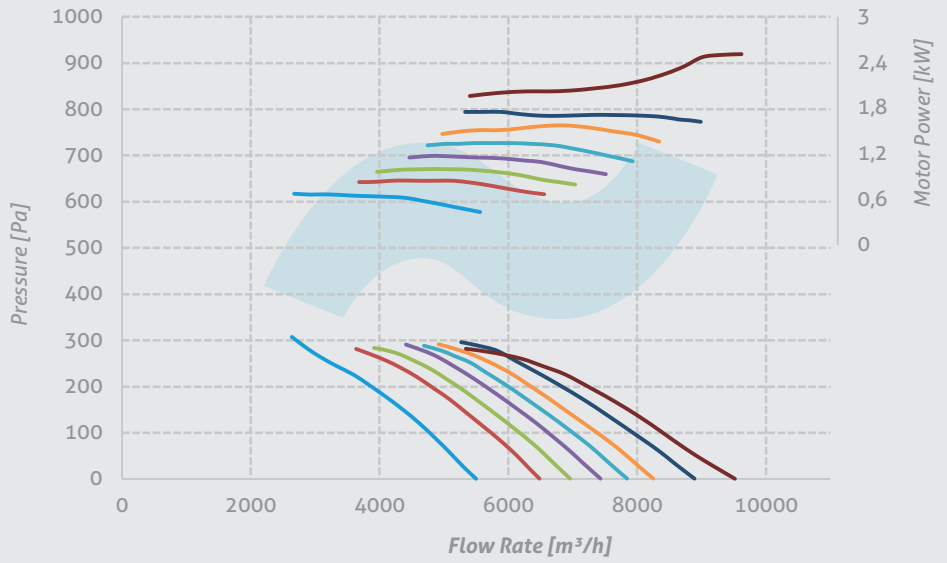

P-FWA 400

Nos. of Blades 5
 Hub Size 5
 Nos. of Poles 4
 Material Aluminum
 Pitch Angle

- 25° 30° 32,5°
- 35° 37,5° 40°
- 45° 50°

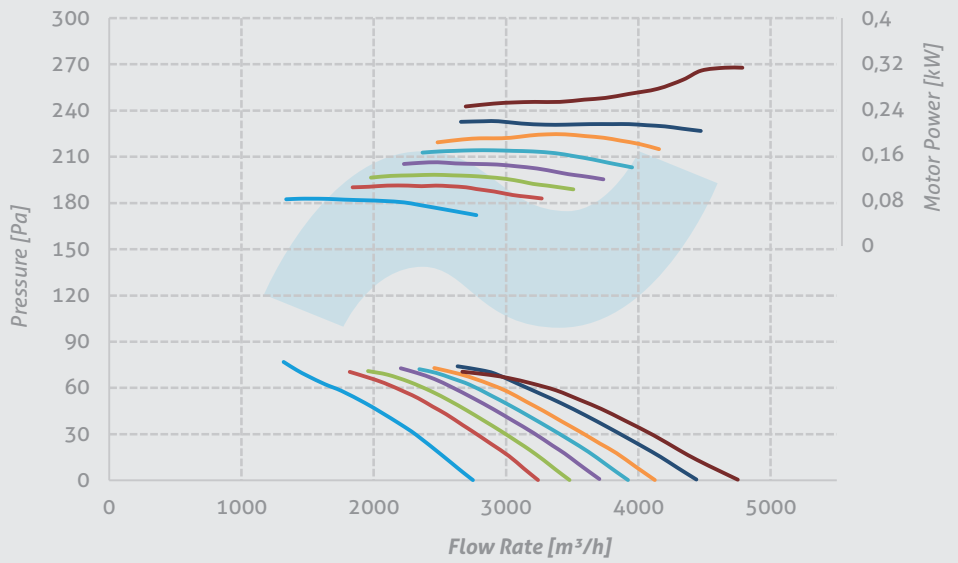

P-FWA 400

Nos. of Blades 5
 Hub Size 5
 Nos. of Poles 6
 Material Aluminum
 Pitch Angle

- 25° 30° 32,5°
- 35° 37,5° 40°
- 45° 50°

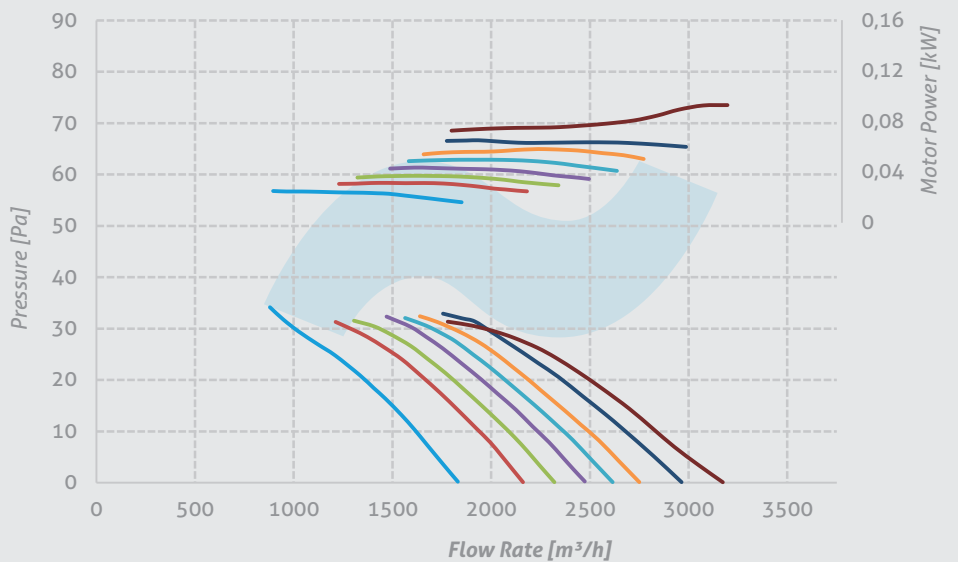

Performance Curves

P-FWA 450

Nos. of Blades 3
Hub Size 6
Pitch Angle 45°
Nos. of Poles 2
Material Aluminum

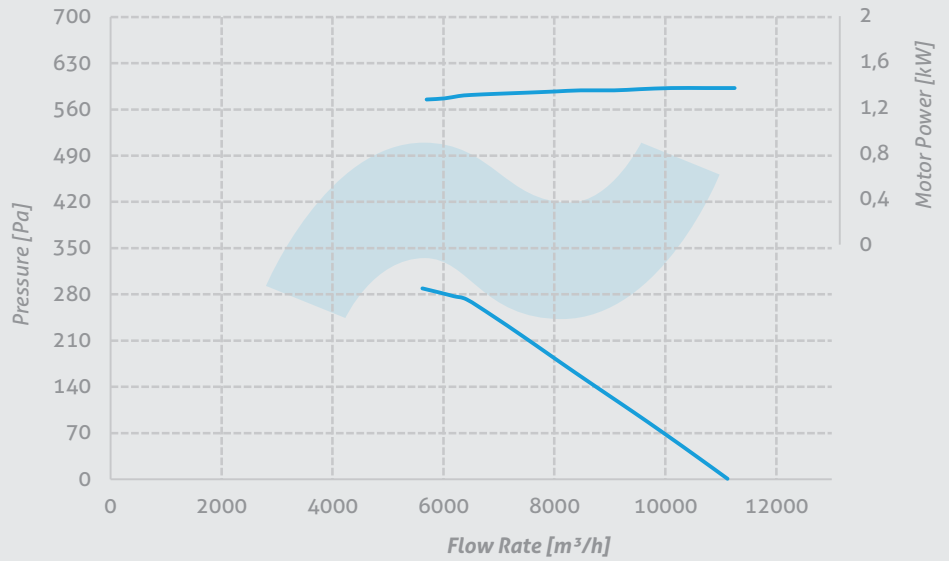

P-FWA 450

Nos. of Blades 3
Hub Size 6
Pitch Angle 45°
Nos. of Poles 4
Material Aluminum

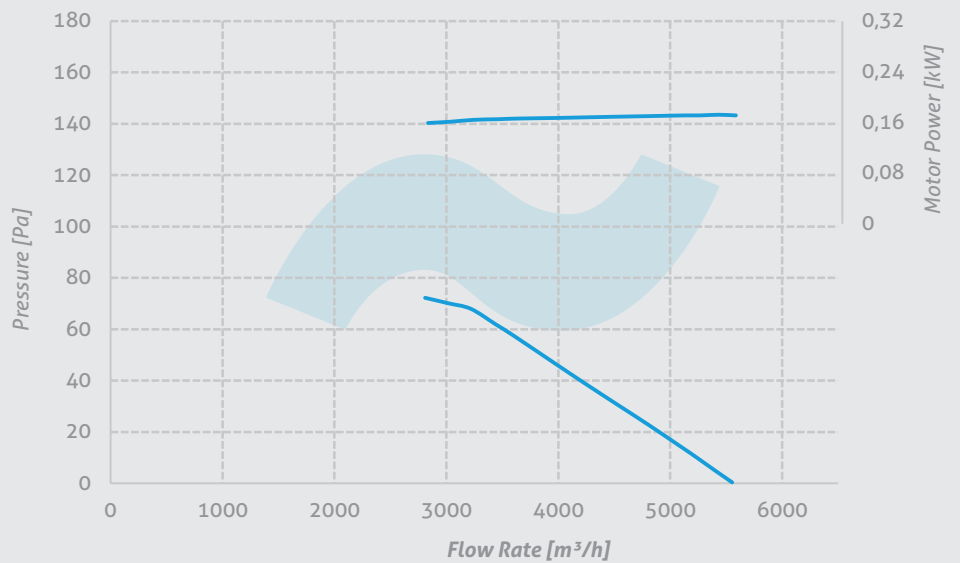

P-FWA 450

Nos. of Blades 3
Hub Size 6
Pitch Angle 45°
Nos. of Poles 6
Material Aluminum

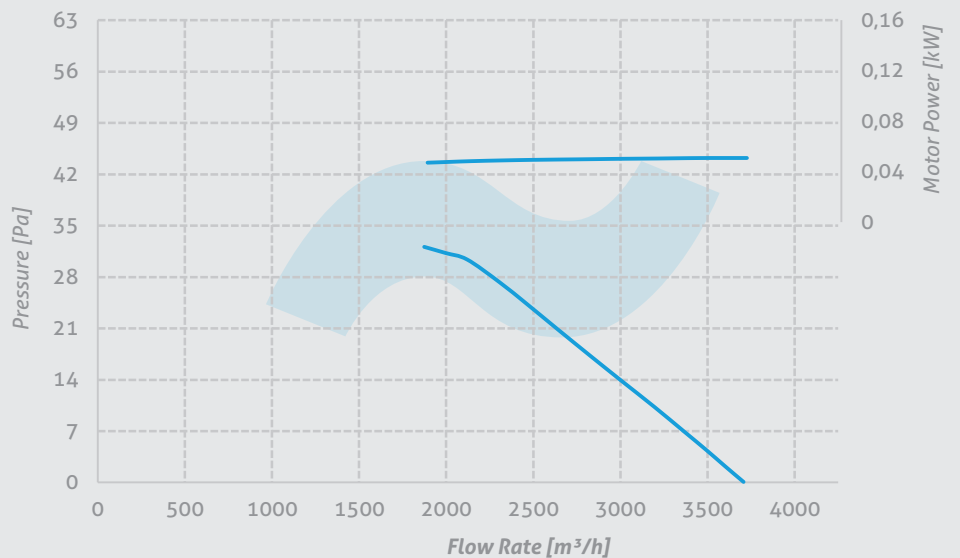

Performance Curves

P-FWA 450

Nos. of Blades 6
Hub Size 6
Pitch Angle 45°
Nos. of Poles 2
Material Aluminum

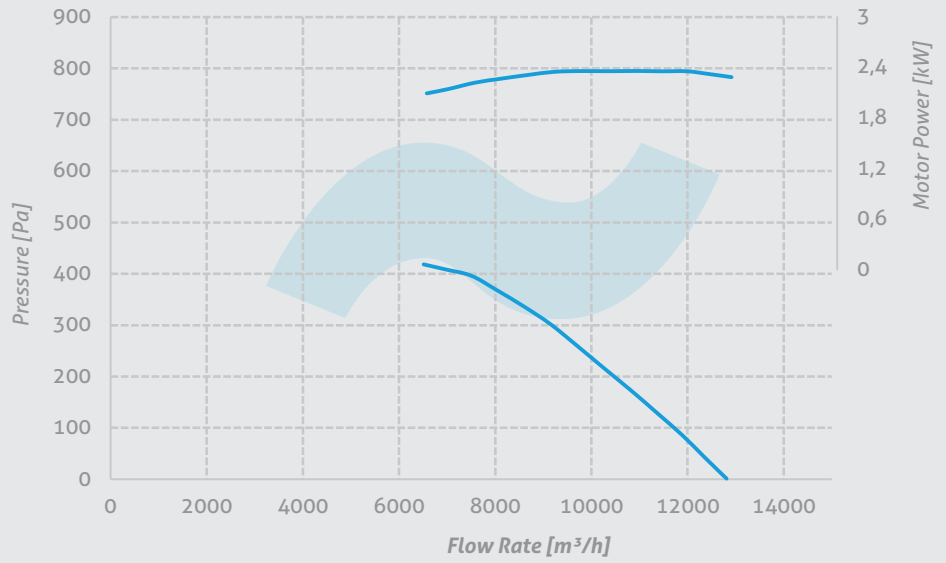

P-FWA 450

Nos. of Blades 6
Hub Size 6
Pitch Angle 45°
Nos. of Poles 4
Material Aluminum

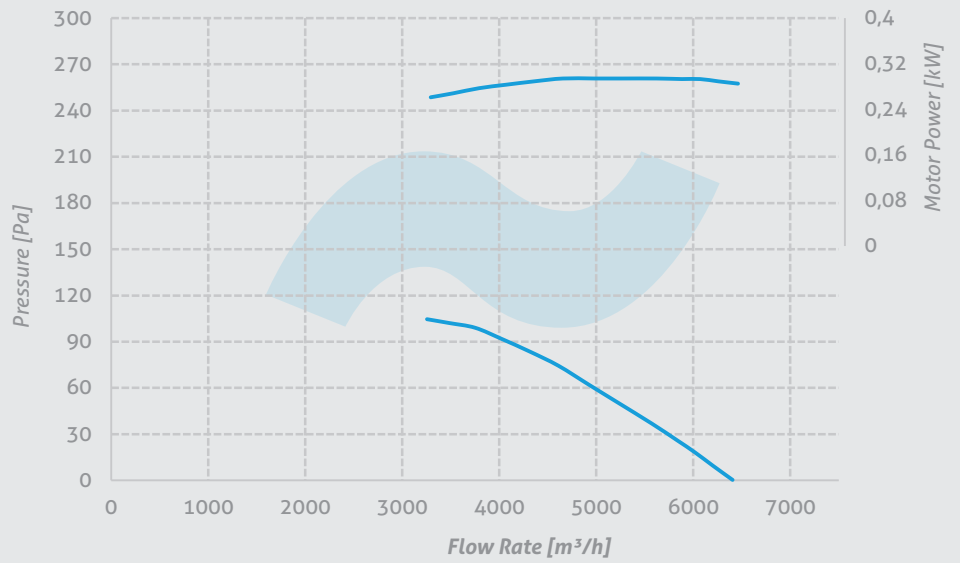

P-FWA 450

Nos. of Blades 6
Hub Size 6
Pitch Angle 45°
Nos. of Poles 6
Material Aluminum

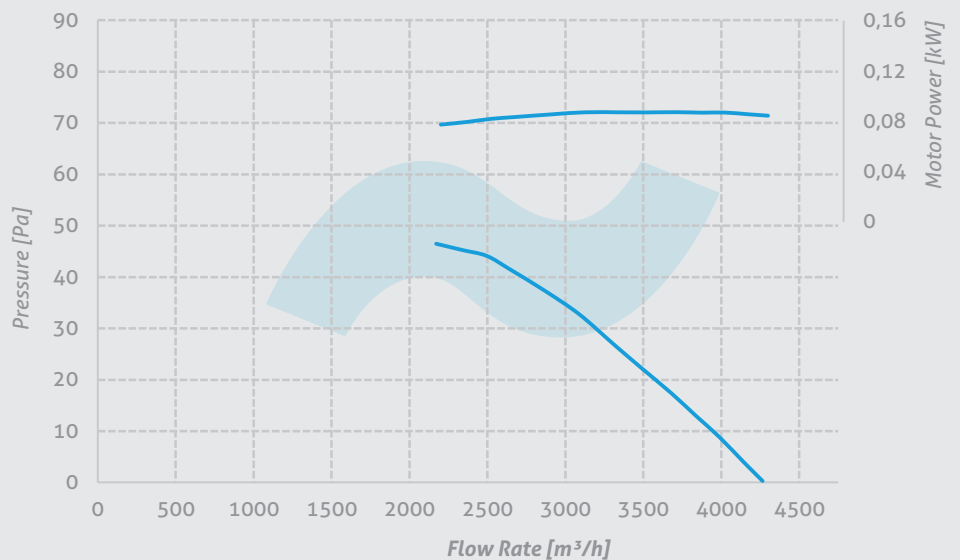

Performance Curves

P-FWA 450

Nos. of Blades 5
 Hub Size 5
 Nos. of Poles 2
 Material Aluminum
 Pitch Angle

- 25° 30° 32,5°
- 35° 37,5° 40°
- 45° 50°

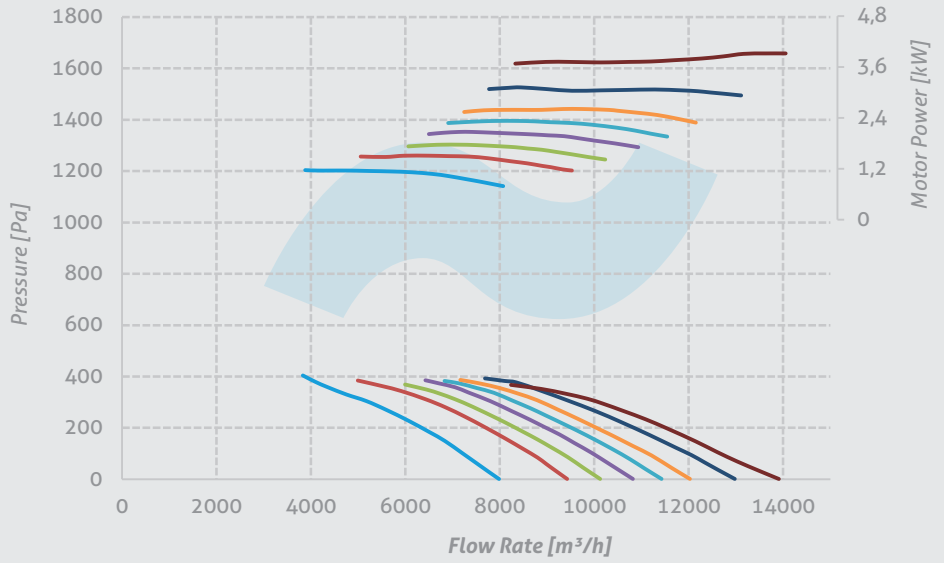

P-FWA 450

Nos. of Blades 5
 Hub Size 5
 Nos. of Poles 4
 Material Aluminum
 Pitch Angle

- 25° 30° 32,5°
- 35° 37,5° 40°
- 45° 50°

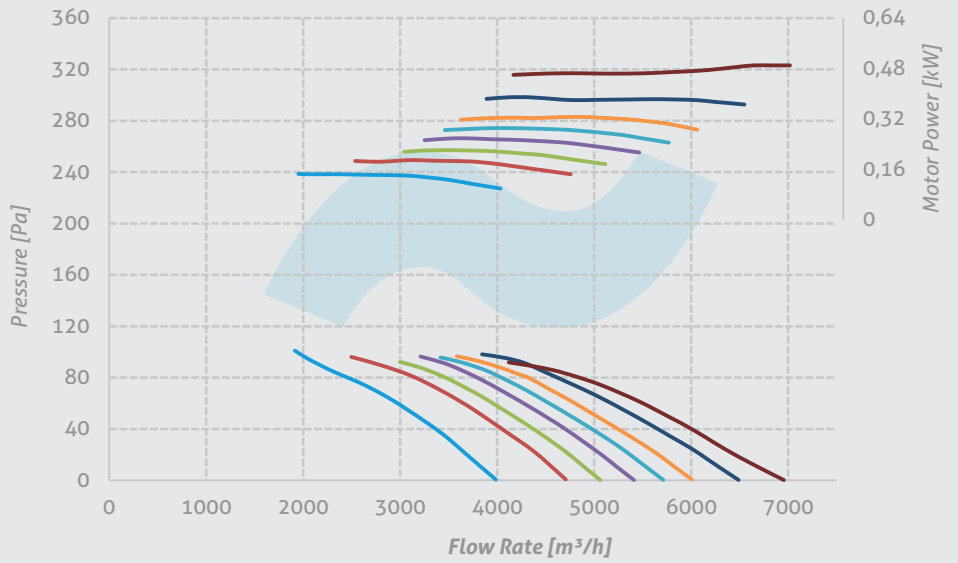

P-FWA 450

Nos. of Blades 5
 Hub Size 5
 Nos. of Poles 6
 Material Aluminum
 Pitch Angle

- 25° 30° 32,5°
- 35° 37,5° 40°
- 45° 50°

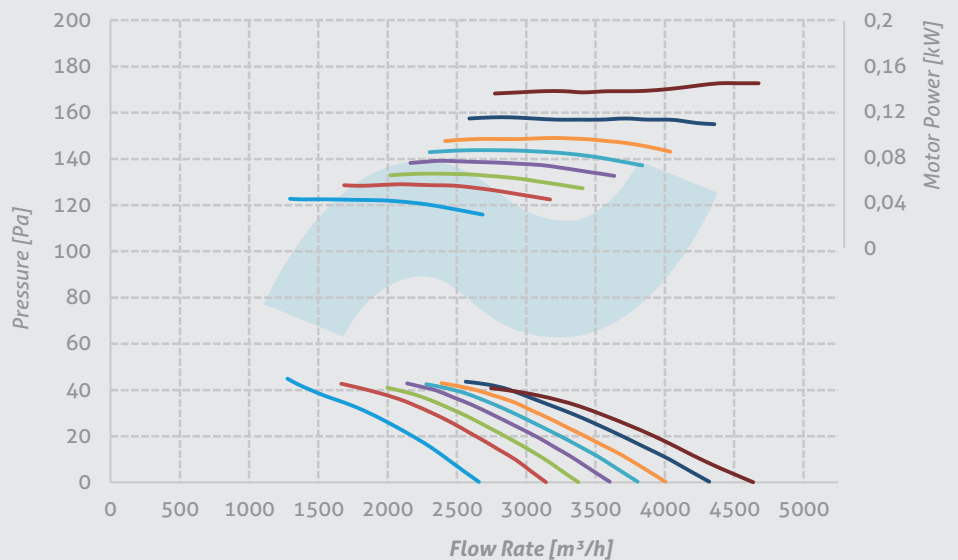

Performance Curves

P-FWA 500

Nos. of Blades 3
 Hub Size 6
 Pitch Angle 45°
 Nos. of Poles 2
 Material Aluminum

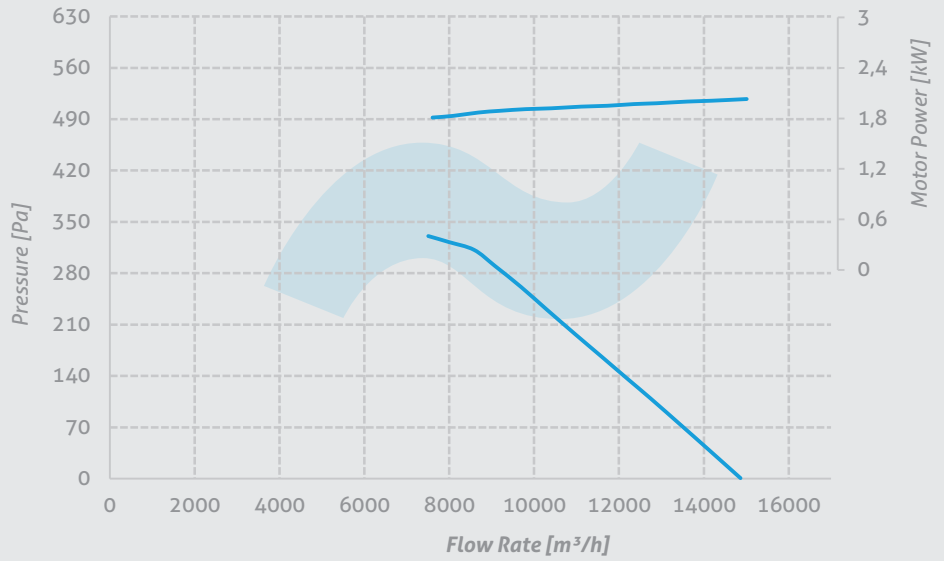

P-FWA 500

Nos. of Blades 3
 Hub Size 6
 Pitch Angle 45°
 Nos. of Poles 4
 Material Aluminum

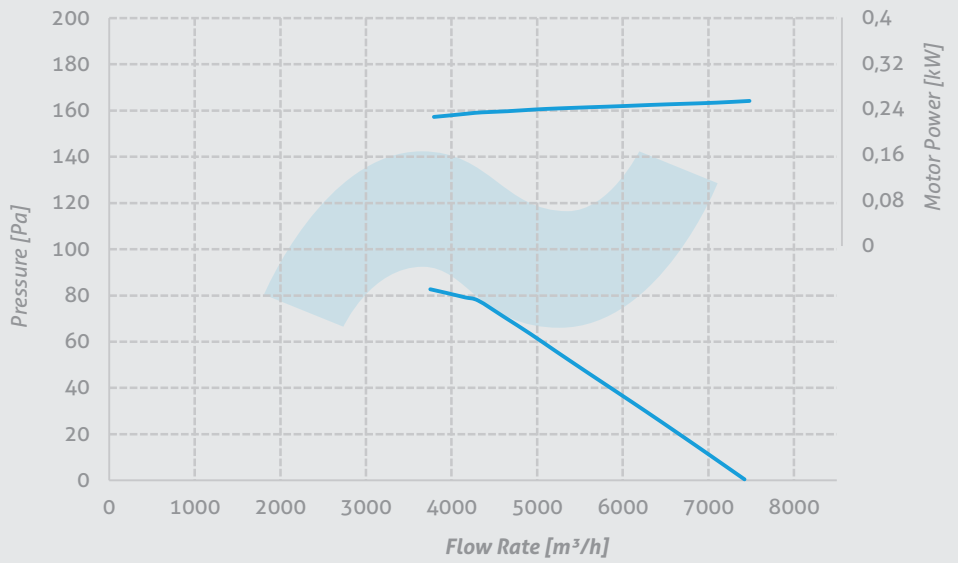

P-FWA 500

Nos. of Blades 3
 Hub Size 6
 Pitch Angle 45°
 Nos. of Poles 6
 Material Aluminum

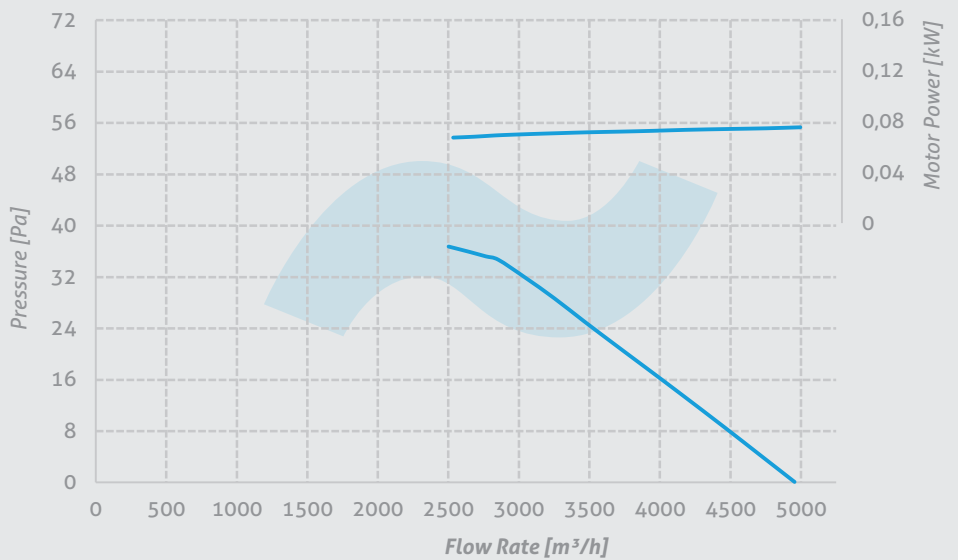

Performance Curves

P-FWA 500

Nos. of Blades 6
Hub Size 6
Pitch Angle 45°
Nos. of Poles 2
Material Aluminum

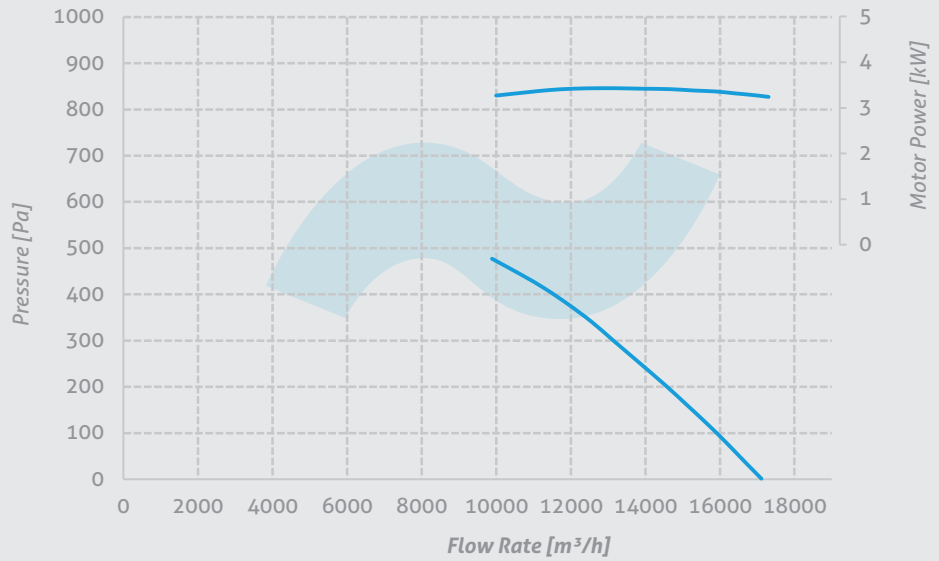

P-FWA 500

Nos. of Blades 6
Hub Size 6
Pitch Angle 45°
Nos. of Poles 4
Material Aluminum

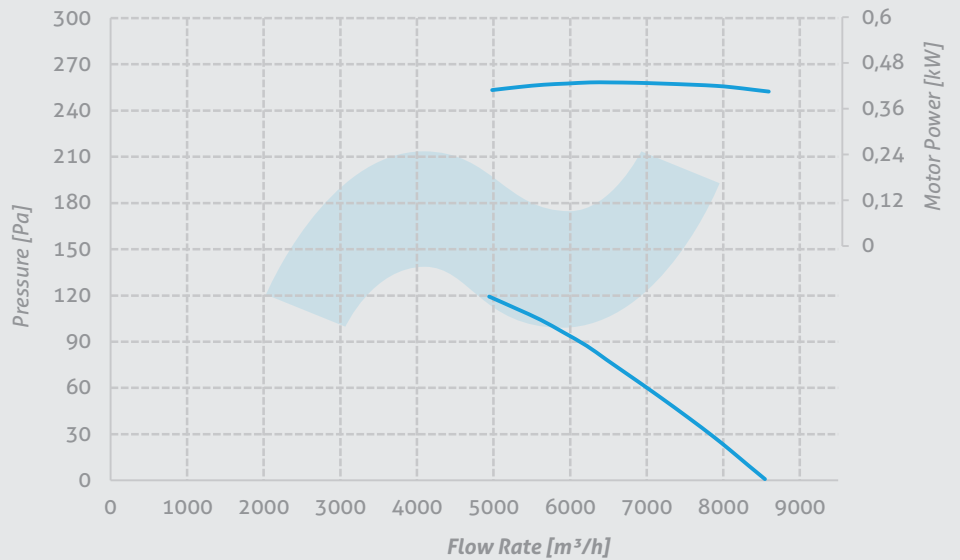

P-FWA 500

Nos. of Blades 6
Hub Size 6
Pitch Angle 45°
Nos. of Poles 6
Material Aluminum

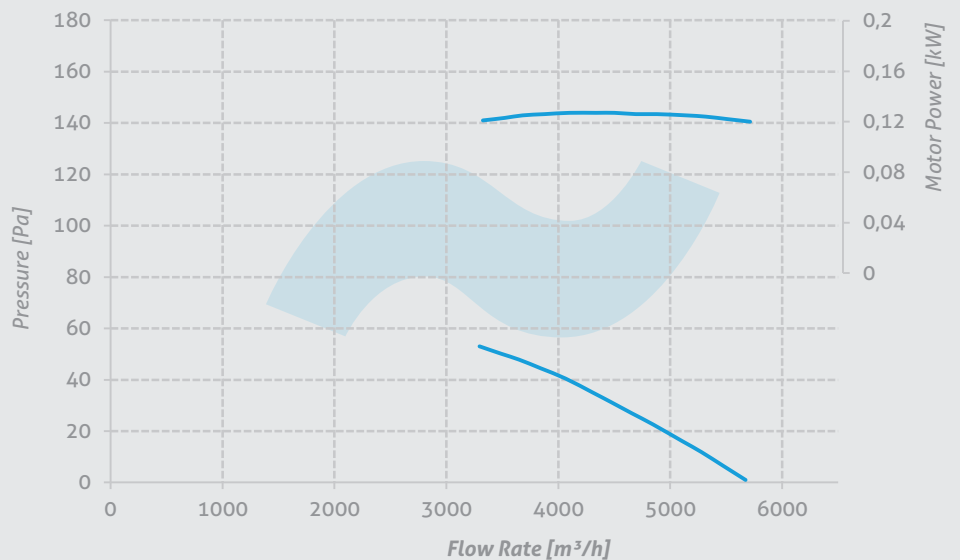

Performance Curves

P-FWA 500

Nos. of Blades 5
 Hub Size 5
 Nos. of Poles 2
 Material Aluminum
 Pitch Angle

- 25° 30° 32,5°
- 35° 37,5° 40°
- 45° 50°

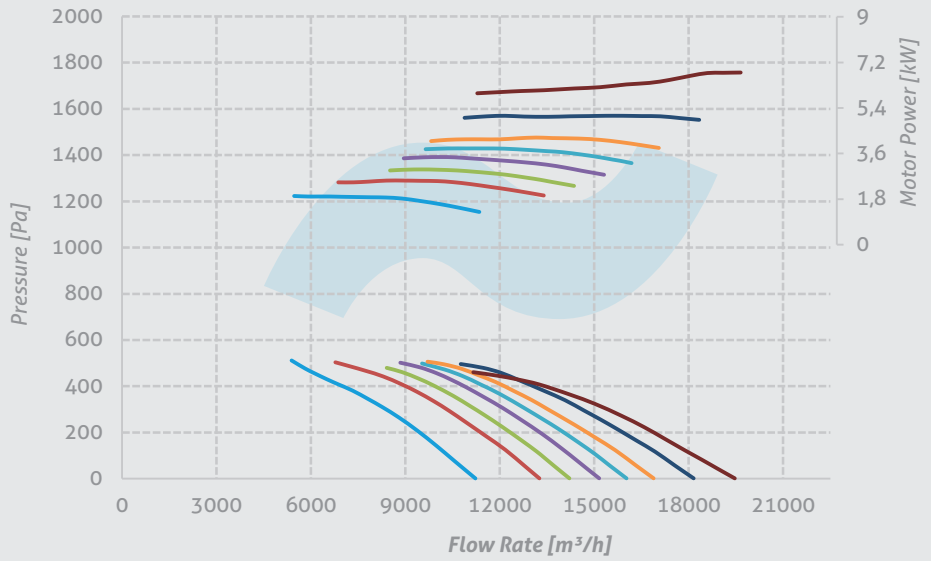

P-FWA 500

Nos. of Blades 5
 Hub Size 5
 Nos. of Poles 4
 Material Aluminum
 Pitch Angle

- 25° 30° 32,5°
- 35° 37,5° 40°
- 45° 50°

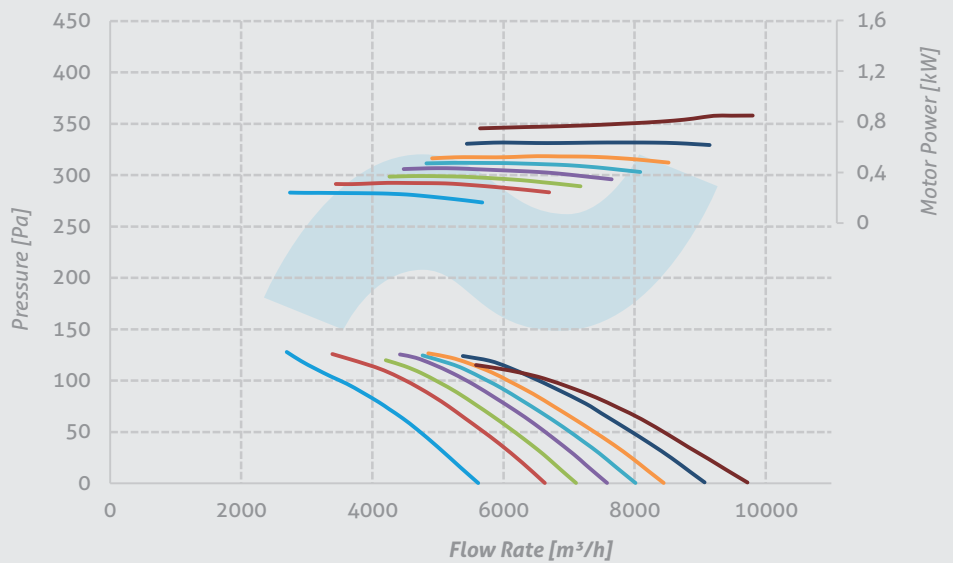

P-FWA 500

Nos. of Blades 5
 Hub Size 5
 Nos. of Poles 6
 Material Aluminum
 Pitch Angle

- 25° 30° 32,5°
- 35° 37,5° 40°
- 45° 50°

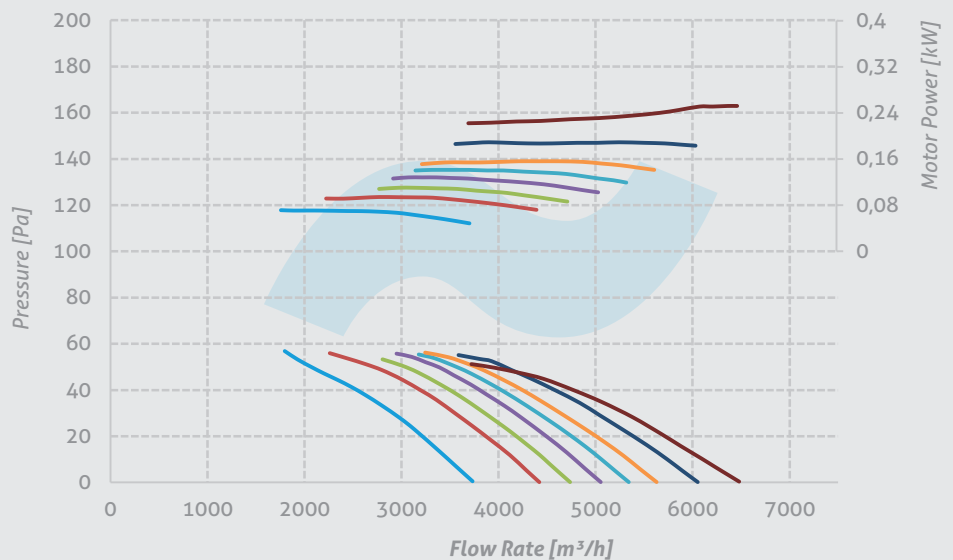

Performance Curves

P-FWA 560

Nos. of Blades 3
Hub Size 6
Pitch Angle 45°
Nos. of Poles 2
Material Aluminum

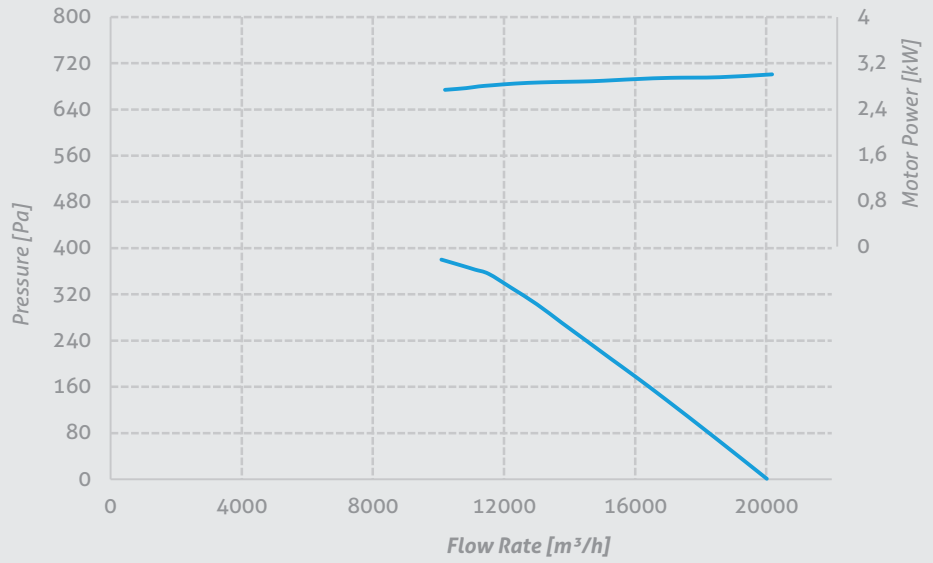

P-FWA 560

Nos. of Blades 3
Hub Size 6
Pitch Angle 45°
Nos. of Poles 4
Material Aluminum

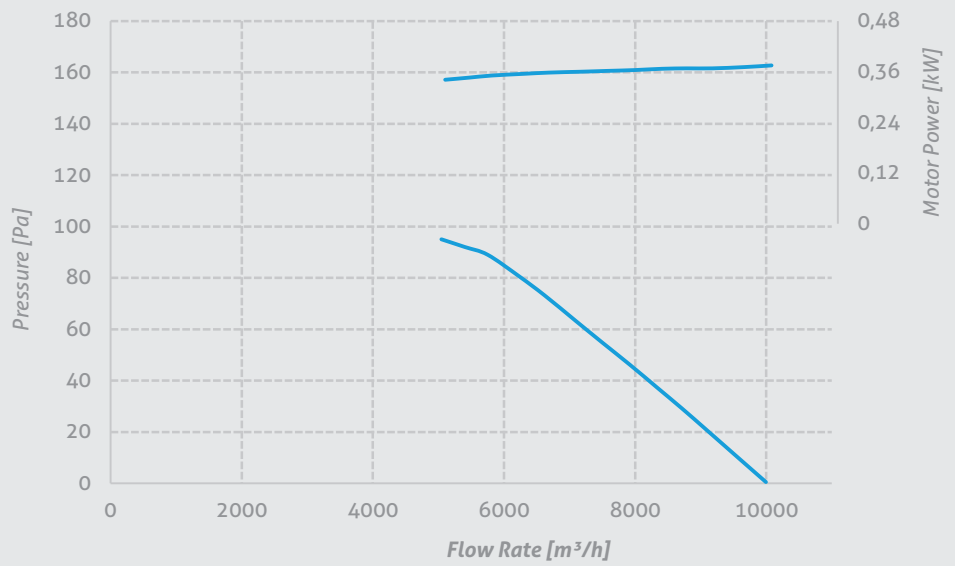

P-FWA 560

Nos. of Blades 3
Hub Size 6
Pitch Angle 45°
Nos. of Poles 6
Material Aluminum

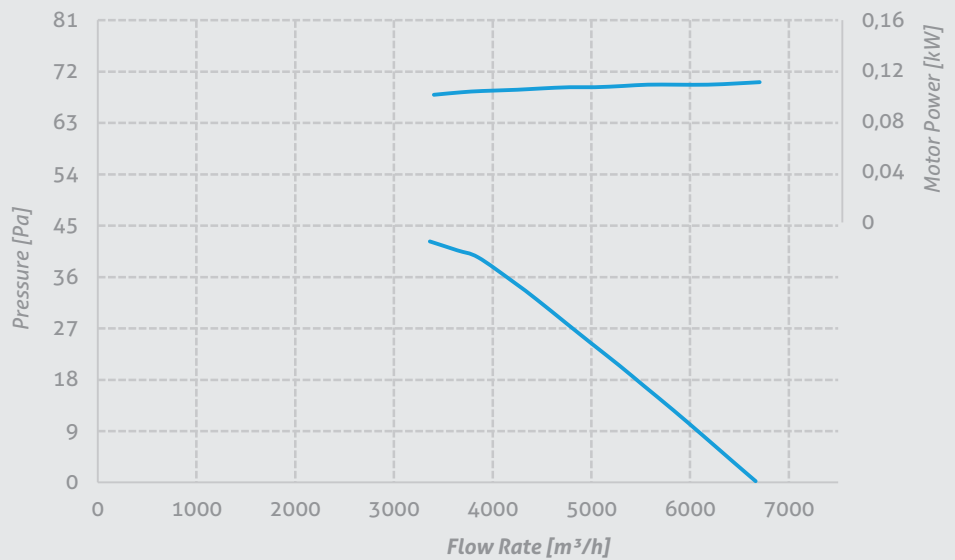

Performance Curves

P-FWA 560

Nos. of Blades 6
Hub Size 6
Pitch Angle 45°
Nos. of Poles 2
Material Aluminum

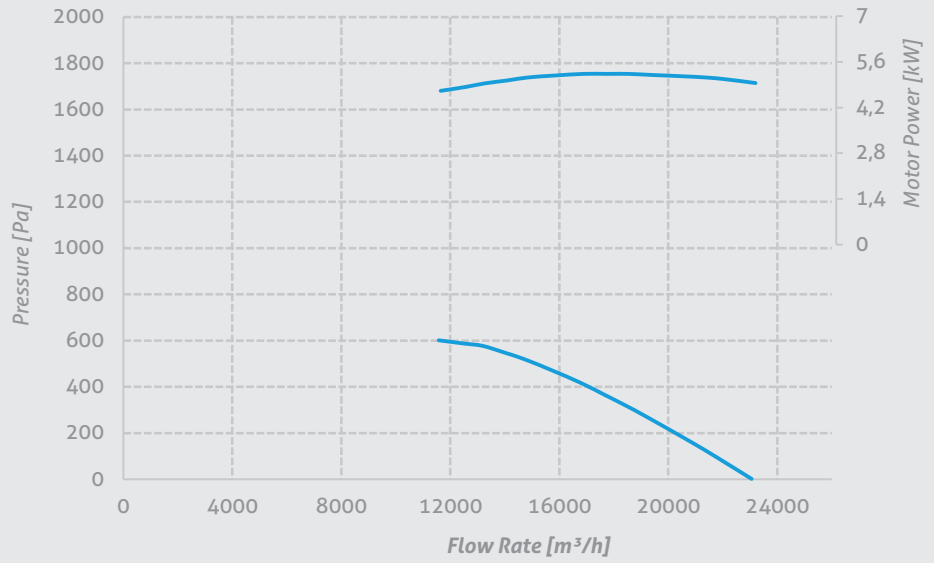

P-FWA 560

Nos. of Blades 6
Hub Size 6
Pitch Angle 45°
Nos. of Poles 4
Material Aluminum

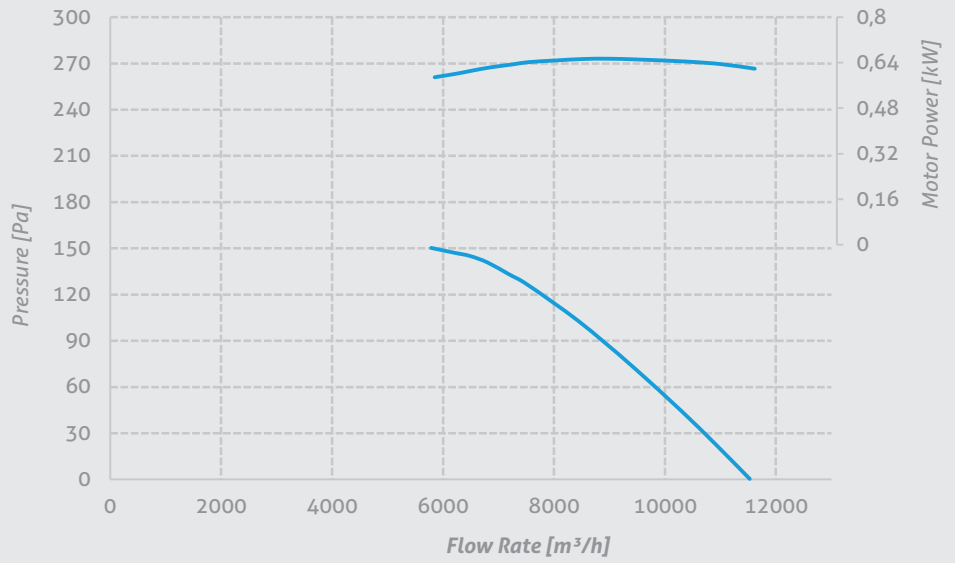

P-FWA 560

Nos. of Blades 6
Hub Size 6
Pitch Angle 45°
Nos. of Poles 6
Material Aluminum

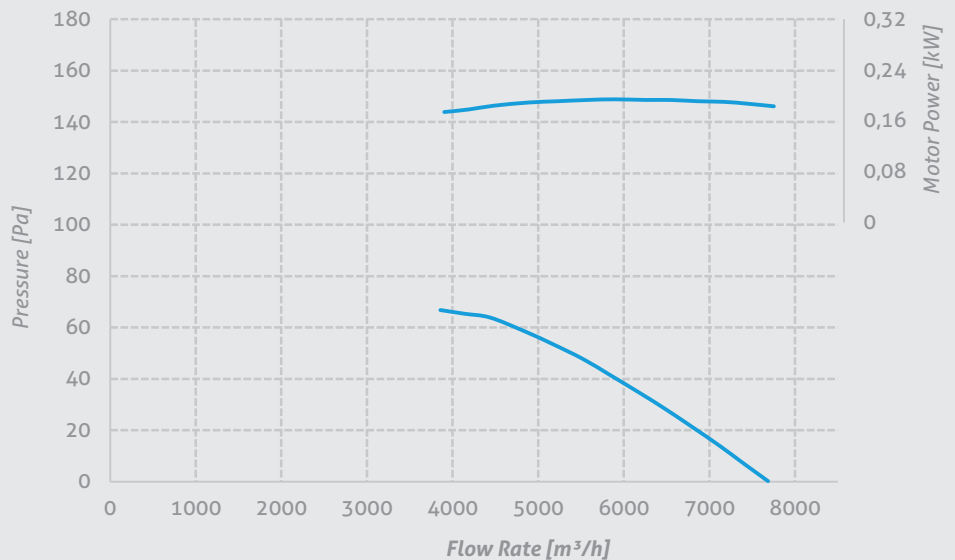

Performance Curves

P-FWA 560

Nos. of Blades 5
 Hub Size 5
 Nos. of Poles 2
 Material Aluminum
 Pitch Angle

- 25° 30° 32,5°
- 35° 37,5° 40°
- 45° 50°

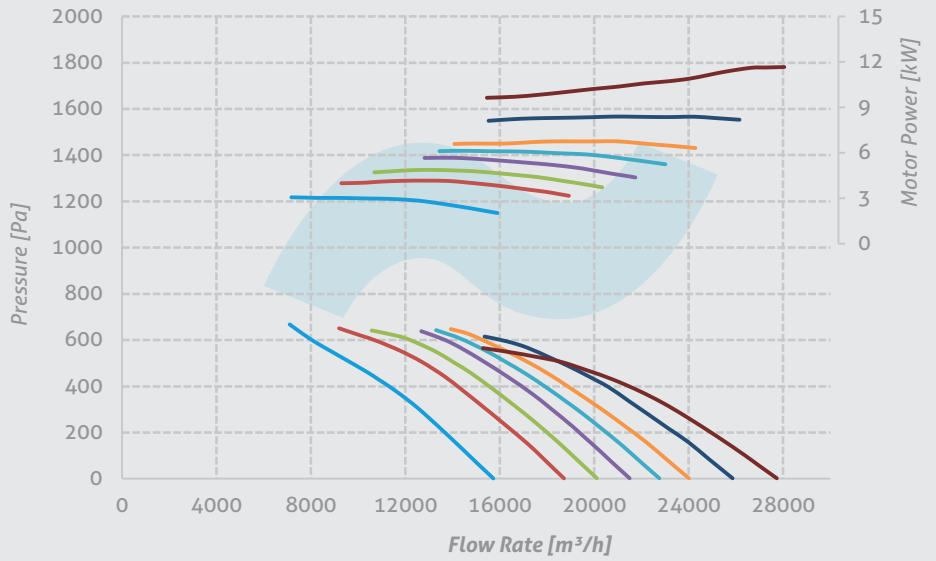

P-FWA 560

Nos. of Blades 5
 Hub Size 5
 Nos. of Poles 4
 Material Aluminum
 Pitch Angle

- 25° 30° 32,5°
- 35° 37,5° 40°
- 45° 50°

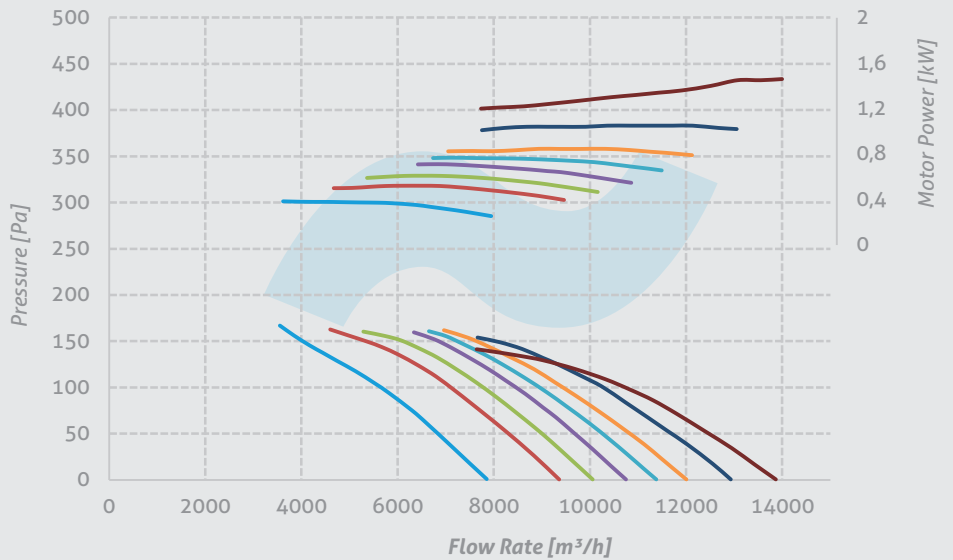

P-FWA 560

Nos. of Blades 5
 Hub Size 5
 Nos. of Poles 6
 Material Aluminum
 Pitch Angle

- 25° 30° 32,5°
- 35° 37,5° 40°
- 45° 50°

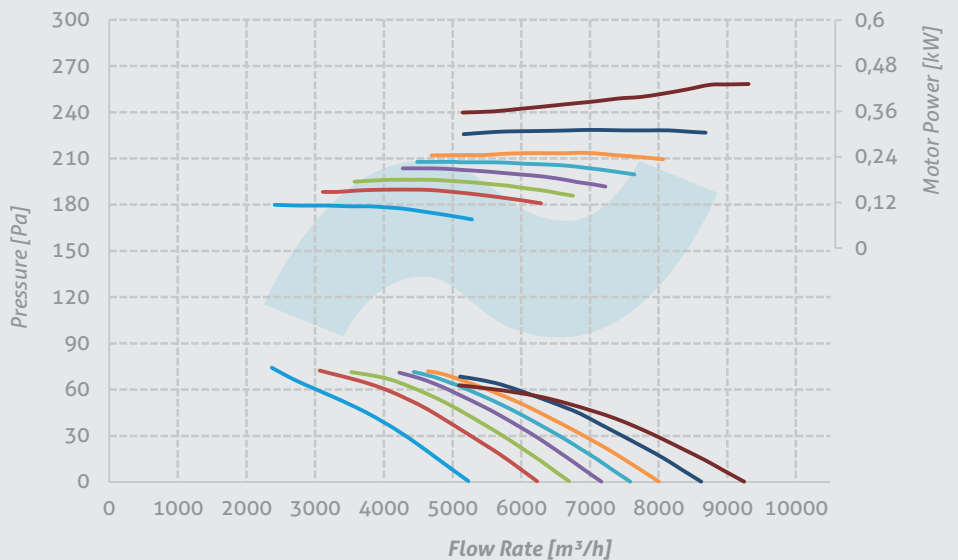

Performance Curves

P-FWA 630

Nos. of Blades 5
 Hub Size 5
 Nos. of Poles 2
 Material Aluminum
 Pitch Angle

- 25° — 30° — 32,5°
- 35° — 37,5° — 40°
- 45°

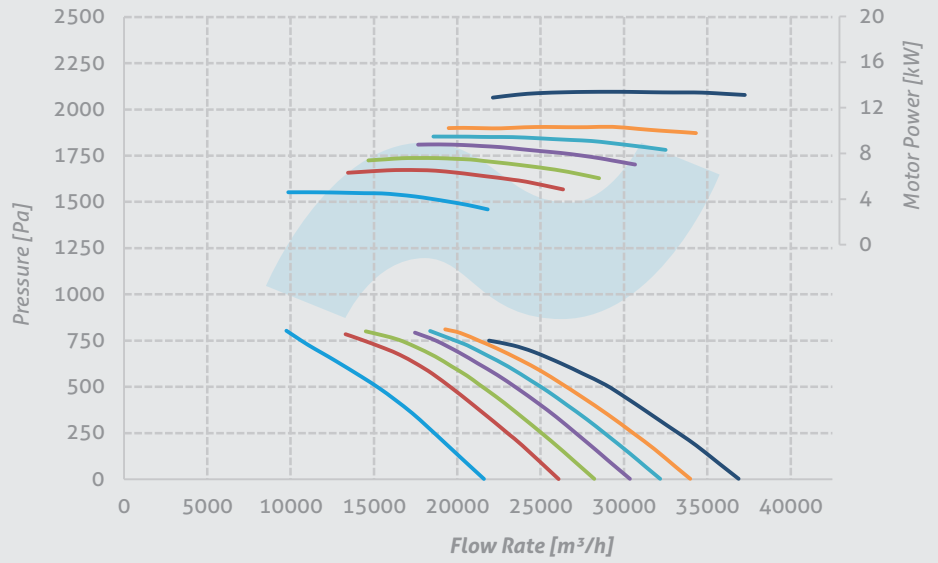

P-FWA 630

Nos. of Blades 5
 Hub Size 5
 Nos. of Poles 4
 Material Aluminum
 Pitch Angle

- 25° — 30° — 32,5°
- 35° — 37,5° — 40°
- 45° — 50°

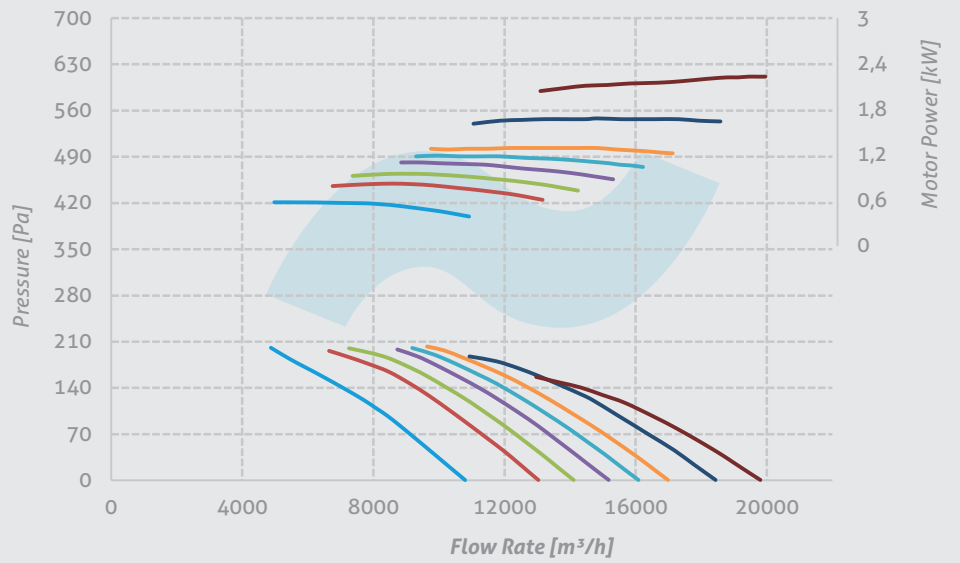

P-FWA 630

Nos. of Blades 5
 Hub Size 5
 Nos. of Poles 6
 Material Aluminum
 Pitch Angle

- 25° — 30° — 32,5°
- 35° — 37,5° — 40°
- 45° — 50°

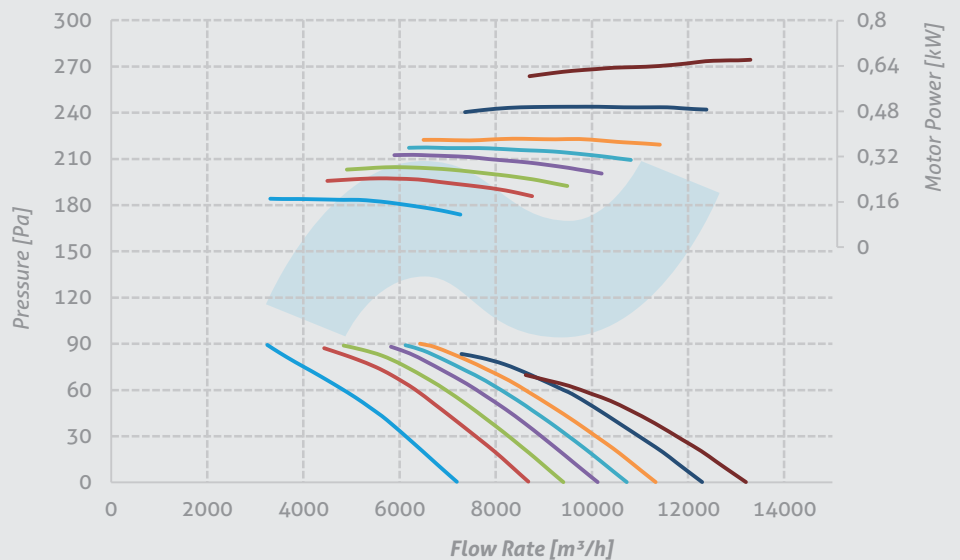

Performance Curves

P-FWA 630

Nos. of Blades 8
 Hub Size 8
 Nos. of Poles 2
 Material Aluminum
 Pitch Angle

25° 30°
 32,5° 35°

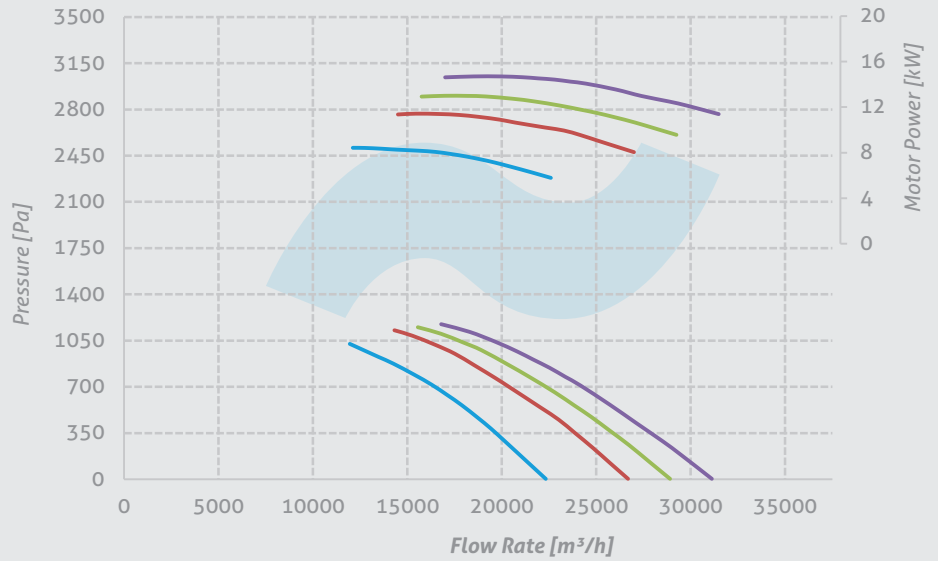

P-FWA 630

Nos. of Blades 8
 Hub Size 8
 Nos. of Poles 4
 Material Aluminum
 Pitch Angle

25° 30° 32,5°
 35° 37,5° 40°
 45° 50°

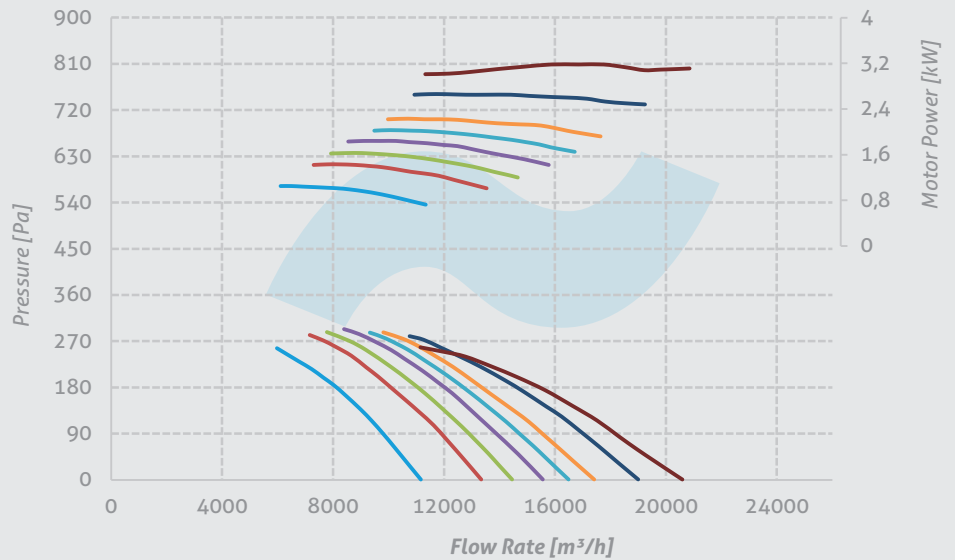

P-FWA 630

Nos. of Blades 8
 Hub Size 8
 Nos. of Poles 6
 Material Aluminum
 Pitch Angle

25° 30° 32,5°
 35° 37,5° 40°
 45° 50°

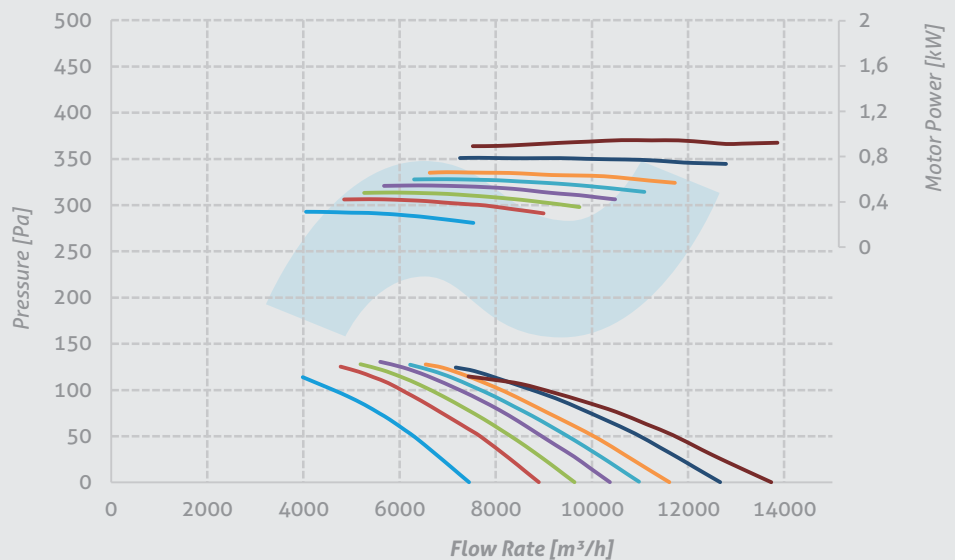

Performance Curves

P-FWA 710

Nos. of Blades 5
 Hub Size 5
 Nos. of Poles 4
 Material Aluminum
 Pitch Angle

- 25° — 30° — 32,5°
- 35° — 37,5° — 40°
- 45° — 50°

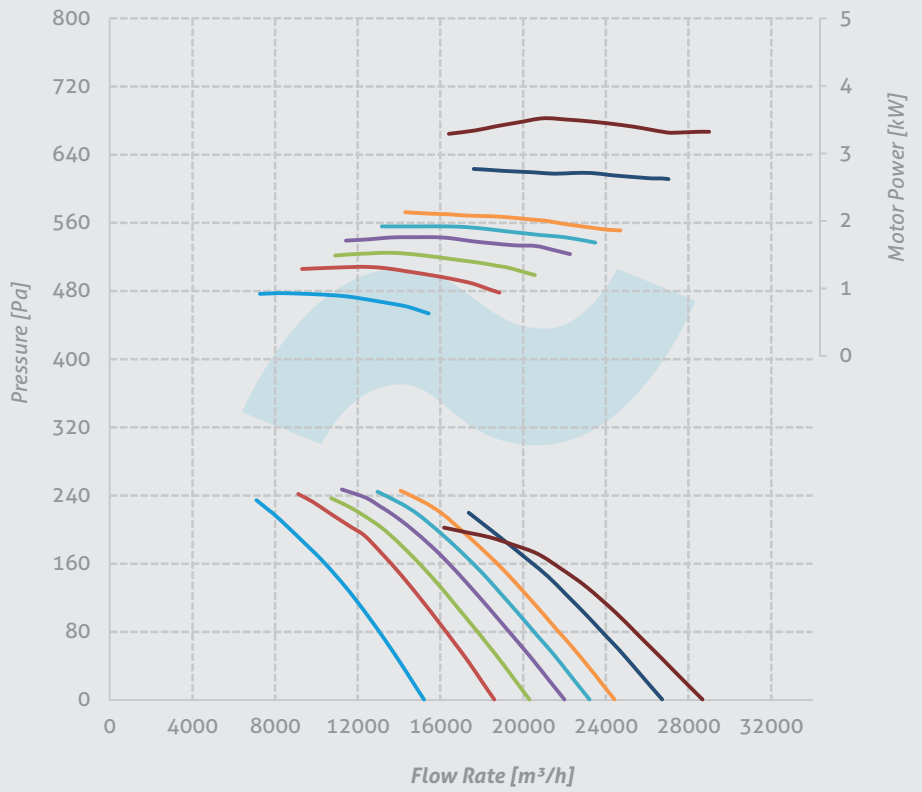

P-FWA 710

Nos. of Blades 5
 Hub Size 5
 Nos. of Poles 6
 Material Aluminum
 Pitch Angle

- 25° — 30° — 32,5°
- 35° — 37,5° — 40°
- 45° — 50°

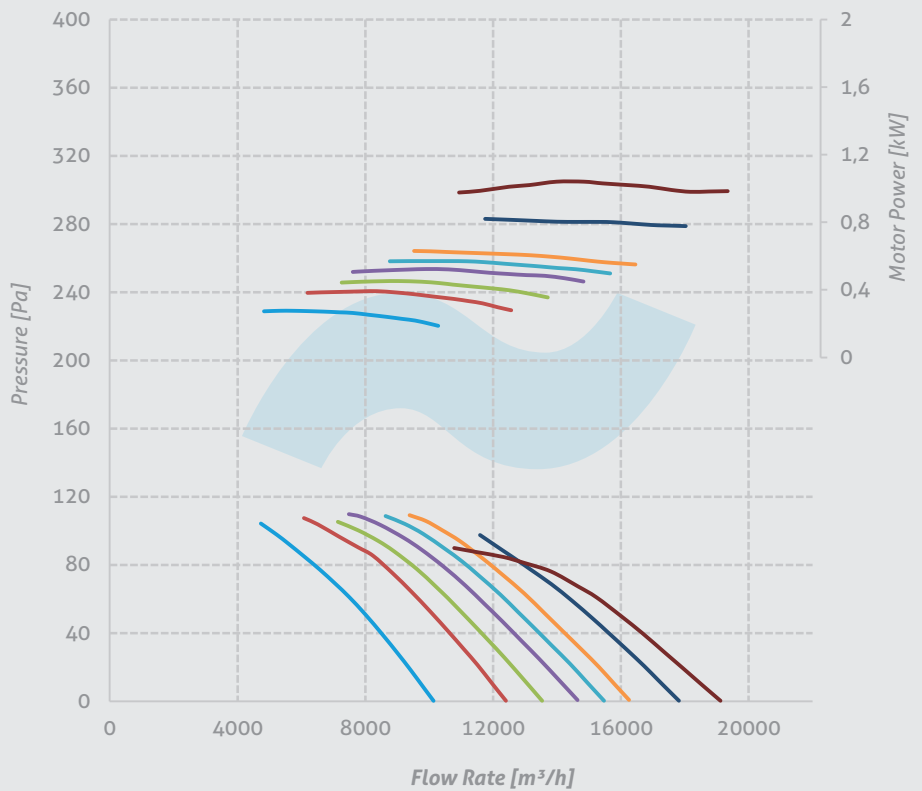

Performance Curves

P-FWA 710

Nos. of Blades 8
 Hub Size 8
 Nos. of Poles 4
 Material Aluminum
 Pitch Angle

- 25° — 30° — 32,5°
- 35° — 37,5° — 40°
- 45° — 50°

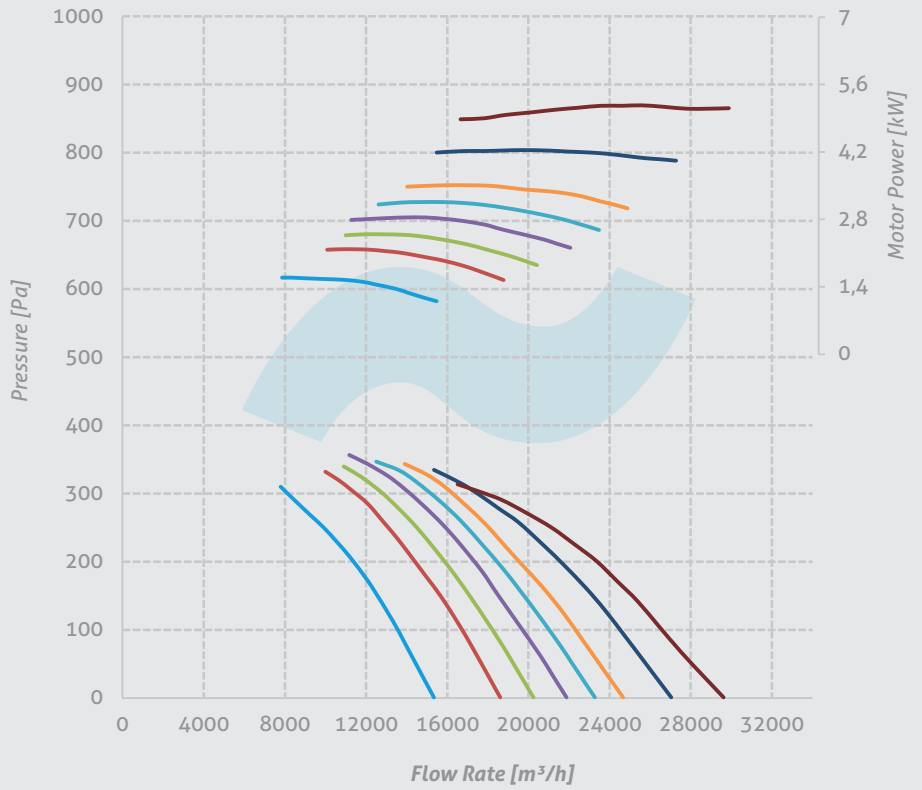

P-FWA 710

Nos. of Blades 8
 Hub Size 8
 Nos. of Poles 6
 Material Aluminum
 Pitch Angle

- 25° — 30° — 32,5°
- 35° — 37,5° — 40°
- 45° — 50°

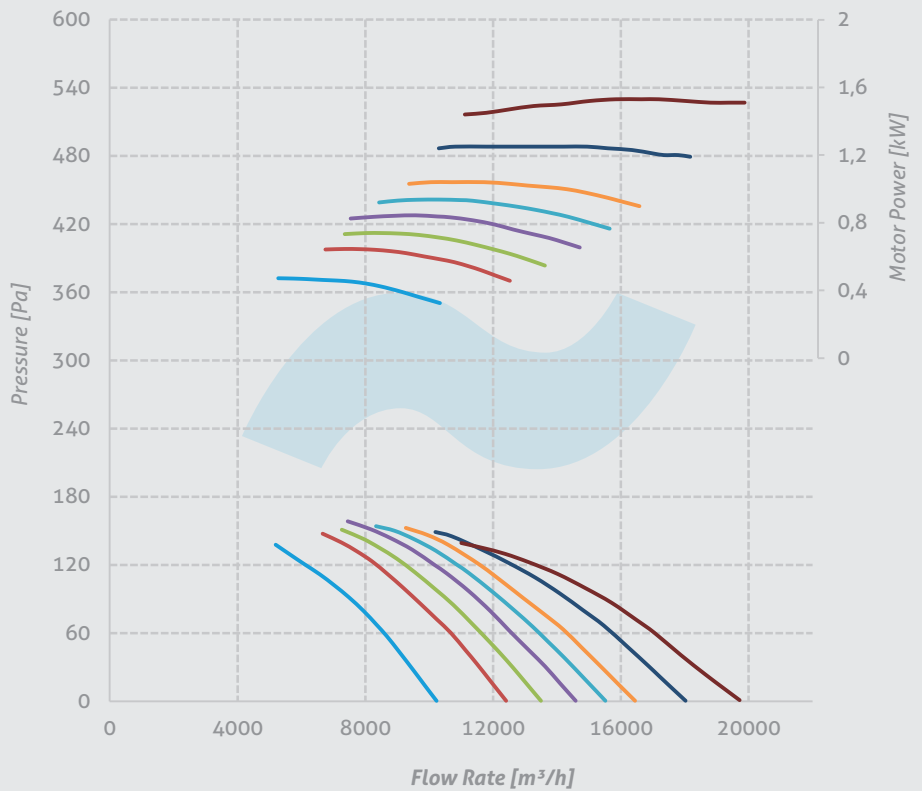

Performance Curves

P-FWA 800

Nos. of Blades 5
 Hub Size 5
 Nos. of Poles 4
 Material Aluminum
 Pitch Angle

- 25° — 30° — 32,5°
- 35° — 37,5° — 40°
- 45° — 50°

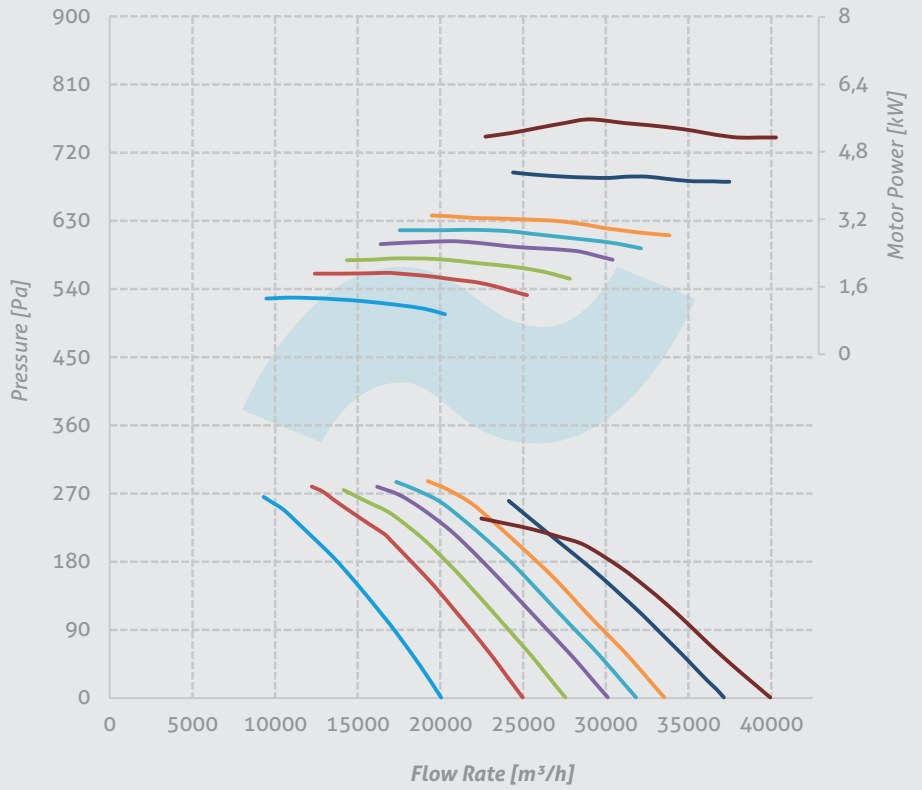

P-FWA 800

Nos. of Blades 5
 Hub Size 5
 Nos. of Poles 6
 Material Aluminum
 Pitch Angle

- 25° — 30° — 32,5°
- 35° — 37,5° — 40°
- 45° — 50°

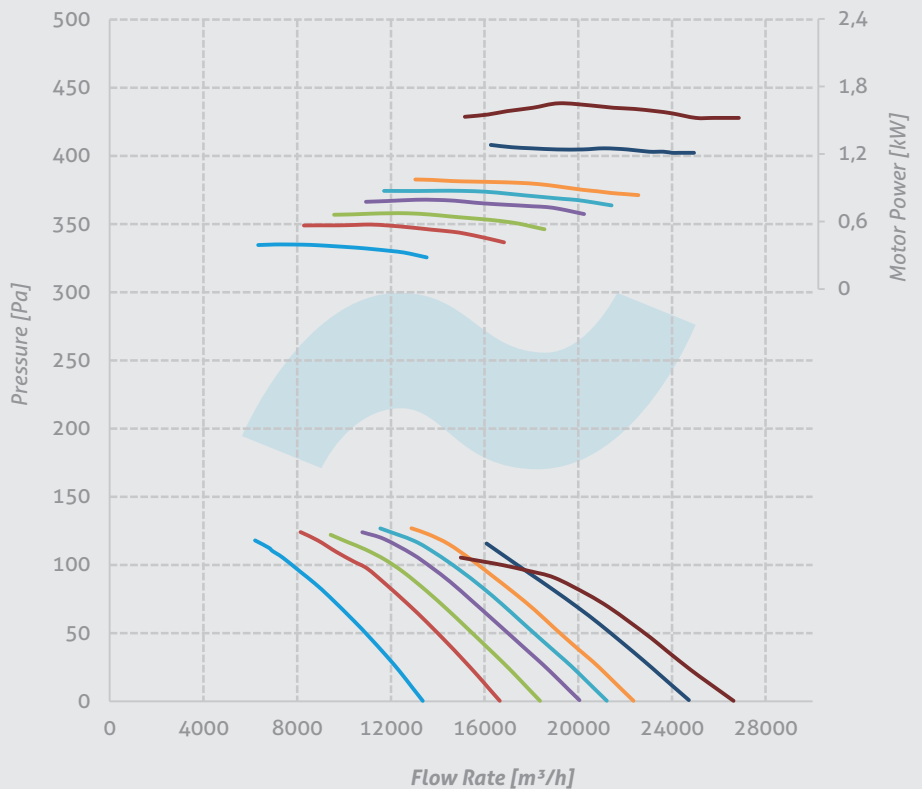

Performance Curves

P-FWA 800

Nos. of Blades 8
 Hub Size 8
 Nos. of Poles 4
 Material Aluminum
 Pitch Angle

- 25° — 30° — 32,5°
- 35° — 37,5° — 40°
- 45° — 50°

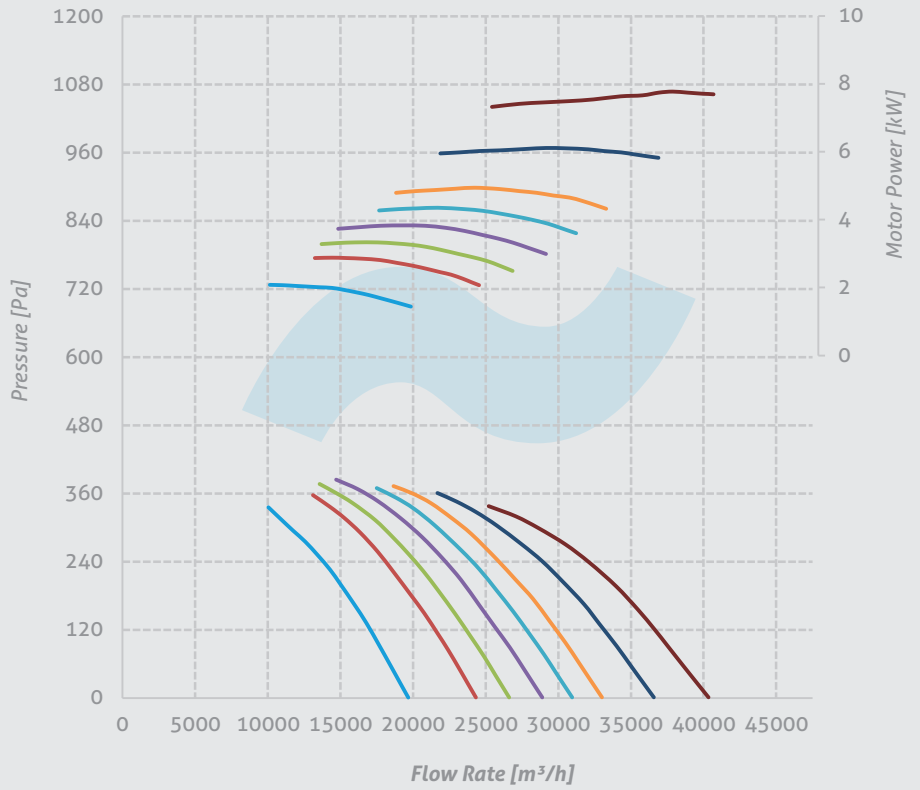

P-FWA 800

Nos. of Blades 8
 Hub Size 8
 Nos. of Poles 6
 Material Aluminum
 Pitch Angle

- 25° — 30° — 32,5°
- 35° — 37,5° — 40°
- 45° — 50°

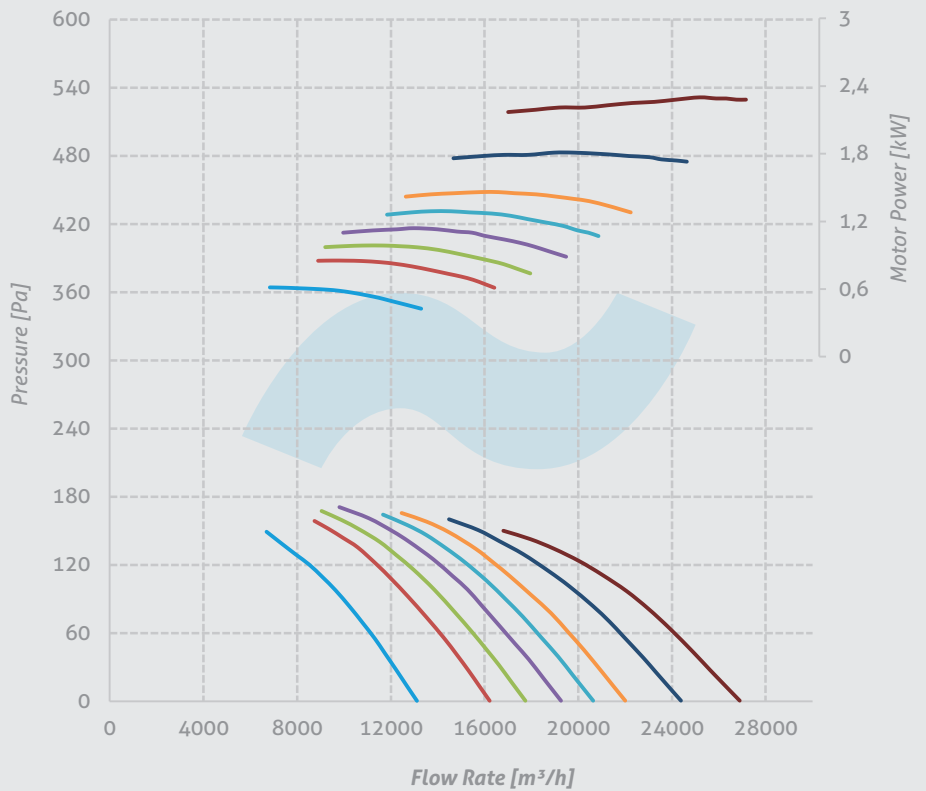

Performance Curves

P-FWA 900

Nos. of Blades 5
 Hub Size 5
 Nos. of Poles 4
 Material Aluminum
 Pitch Angle

- 25° — 30° — 32,5°
- 35° — 37,5° — 40°
- 45° — 50°

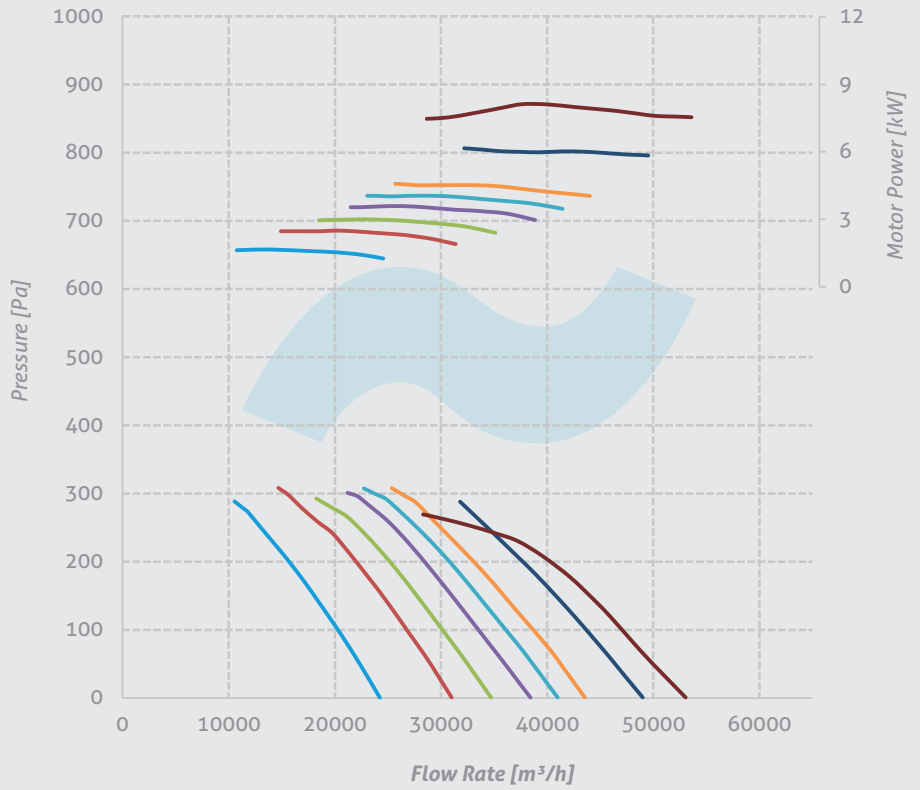

P-FWA 900

Nos. of Blades 5
 Hub Size 5
 Nos. of Poles 6
 Material Aluminum
 Pitch Angle

- 25° — 30° — 32,5°
- 35° — 37,5° — 40°
- 45° — 50°

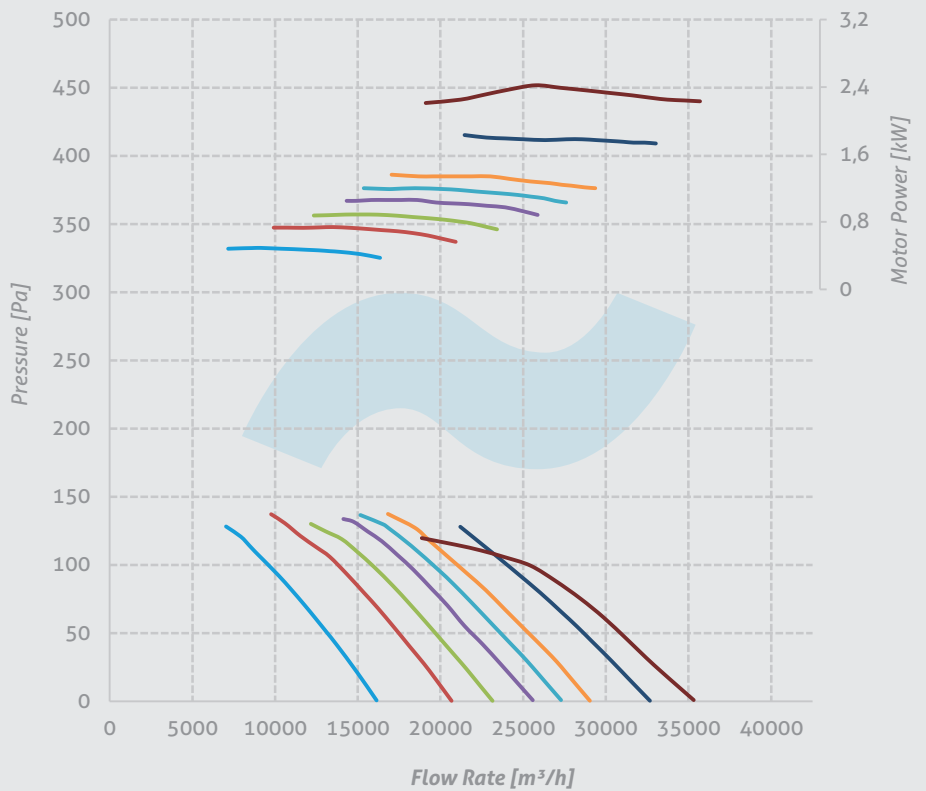

Performance Curves

P-FWA 900

Nos. of Blades 8
 Hub Size 8
 Nos. of Poles 4
 Material Aluminum
 Pitch Angle

- 25° — 30° — 32,5°
- 35° — 37,5° — 40°
- 45° — 50°

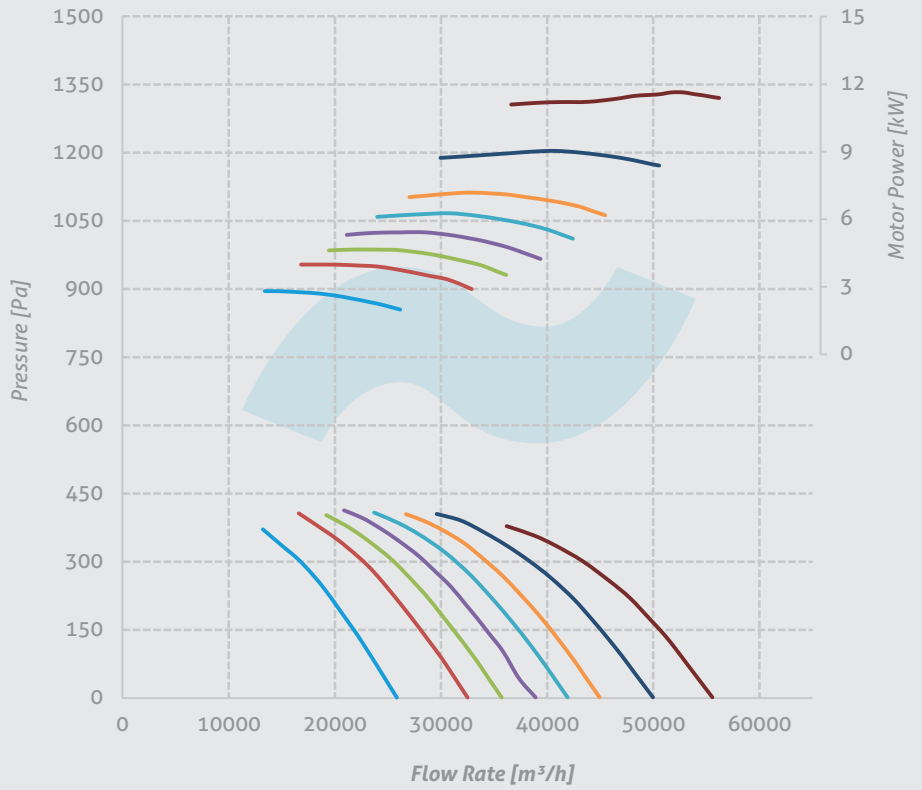

P-FWA 900

Nos. of Blades 8
 Hub Size 8
 Nos. of Poles 6
 Material Aluminum
 Pitch Angle

- 25° — 30° — 32,5°
- 35° — 37,5° — 40°
- 45° — 50°

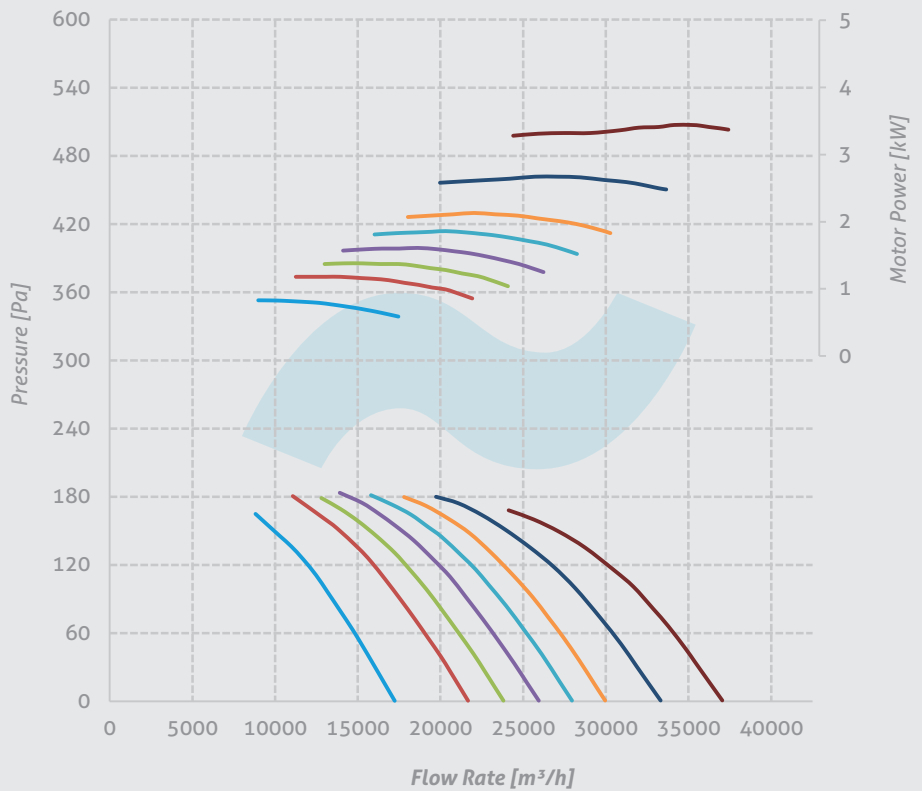

Performance Curves

P-FWA 1000

Nos. of Blades 5
 Hub Size 5
 Nos. of Poles 4
 Material Aluminum
 Pitch Angle

- 25° — 30° — 32,5°
- 35° — 37,5° — 40°
- 45° — 50°

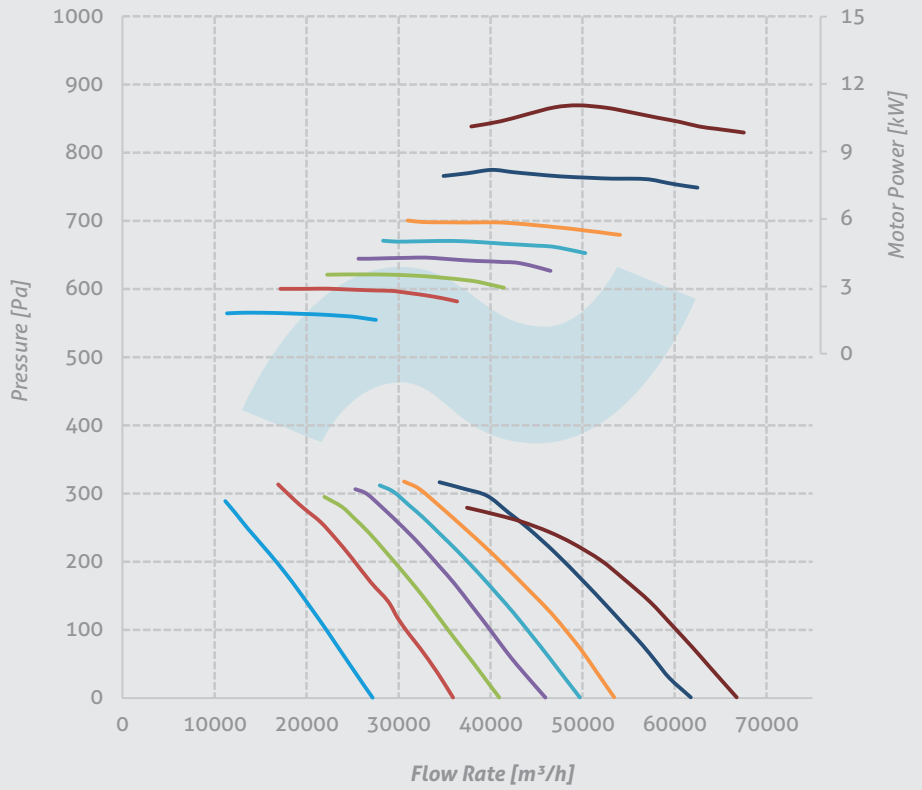

P-FWA 1000

Nos. of Blades 5
 Hub Size 5
 Nos. of Poles 6
 Material Aluminum
 Pitch Angle

- 25° — 30° — 32,5°
- 35° — 37,5° — 40°
- 45° — 50°

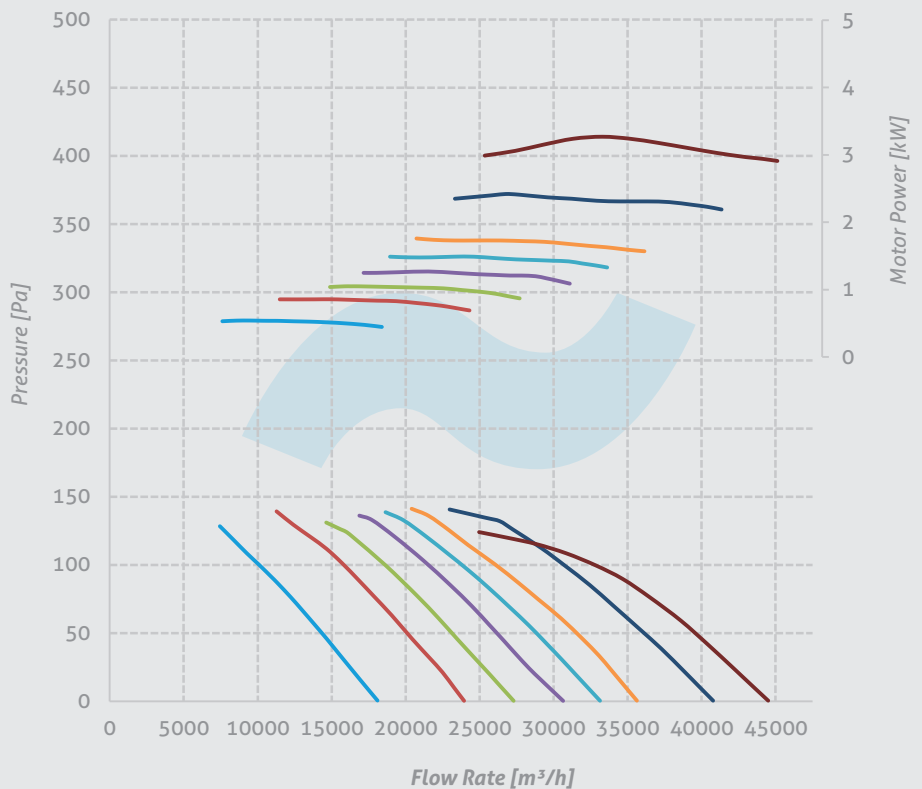

Performance Curves

P-FWA 1000

Nos. of Blades 8
 Hub Size 8
 Nos. of Poles 4
 Material Aluminum
 Pitch Angle

- 25° — 30° — 32,5°
- 35° — 37,5° — 40°
- 45° — 50°

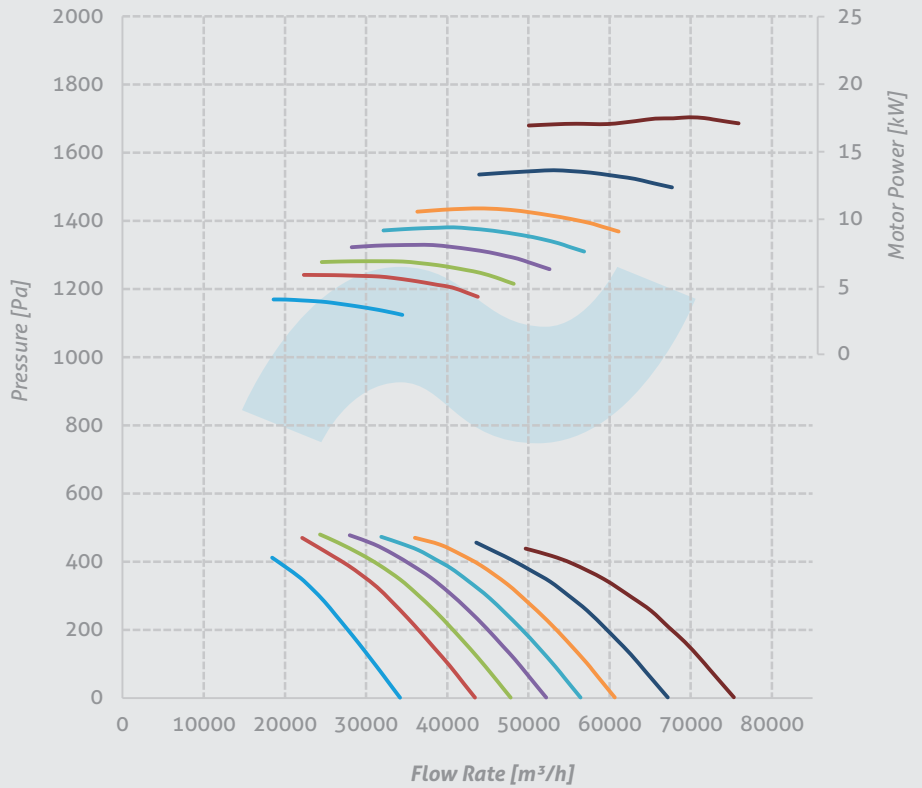

P-FWA 1000

Nos. of Blades 8
 Hub Size 8
 Nos. of Poles 6
 Material Aluminum
 Pitch Angle

- 25° — 30° — 32,5°
- 35° — 37,5° — 40°
- 45° — 50°

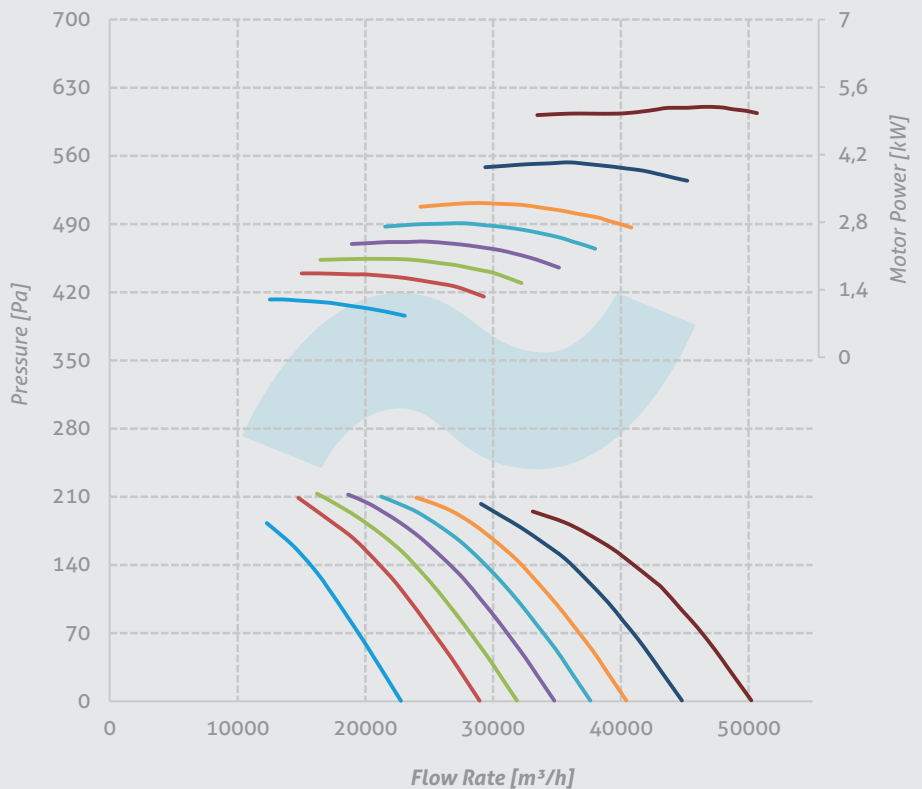

Performance Curves

P-FWA 1120

Nos. of Blades 8
 Hub Size 8
 Nos. of Poles 4
 Material Aluminum
 Pitch Angle

- 25° — 30° — 32,5°
- 35° — 37,5° — 40°
- 45° — 50°

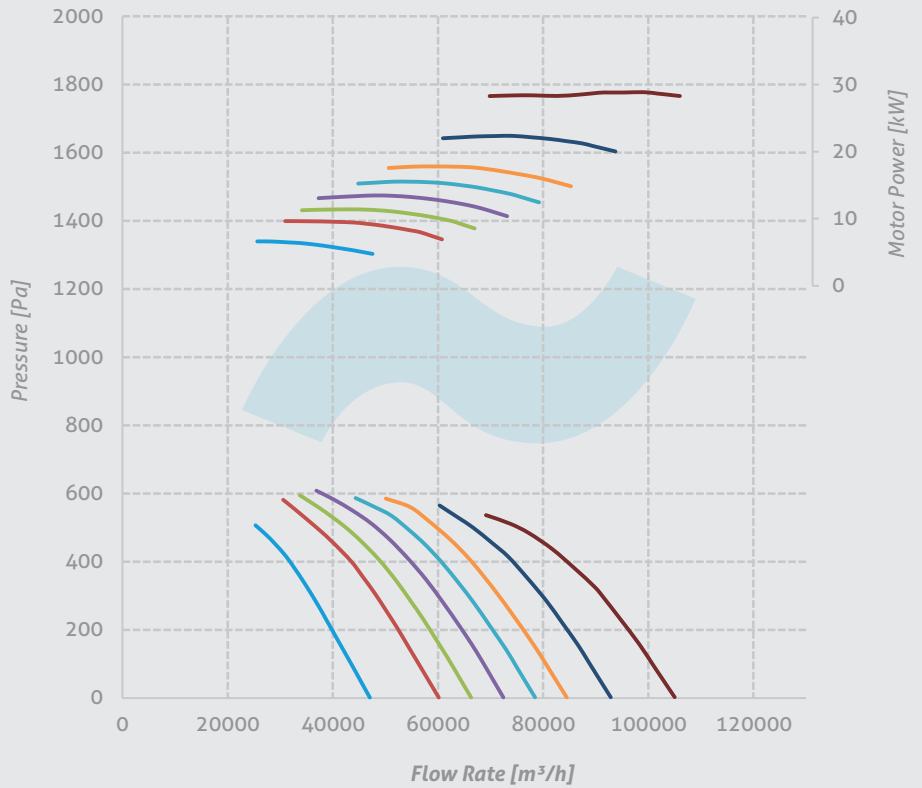

P-FWA 1120

Nos. of Blades 8
 Hub Size 8
 Nos. of Poles 6
 Material Aluminum
 Pitch Angle

- 25° — 30° — 32,5°
- 35° — 37,5° — 40°
- 45° — 50°

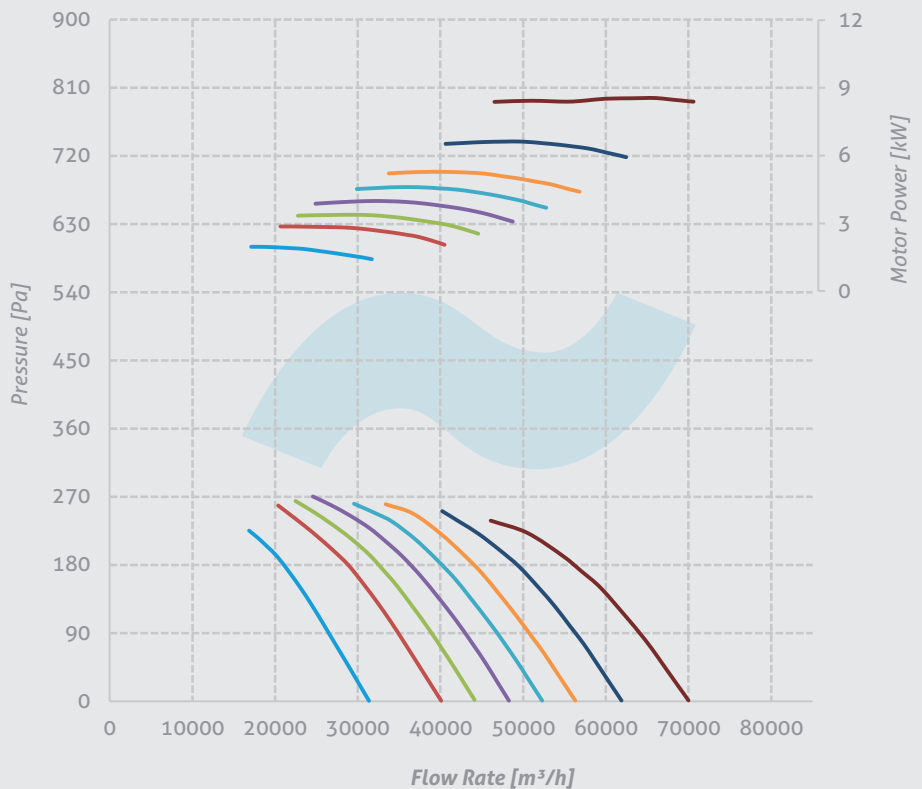

Performance Curves

P-FWA 1120

Nos. of Blades 12
 Hub Size 12
 Nos. of Poles 4
 Material Aluminum
 Pitch Angle

- 25° — 30° — 32,5°
- 35° — 37,5° — 40°
- 45° — 50°

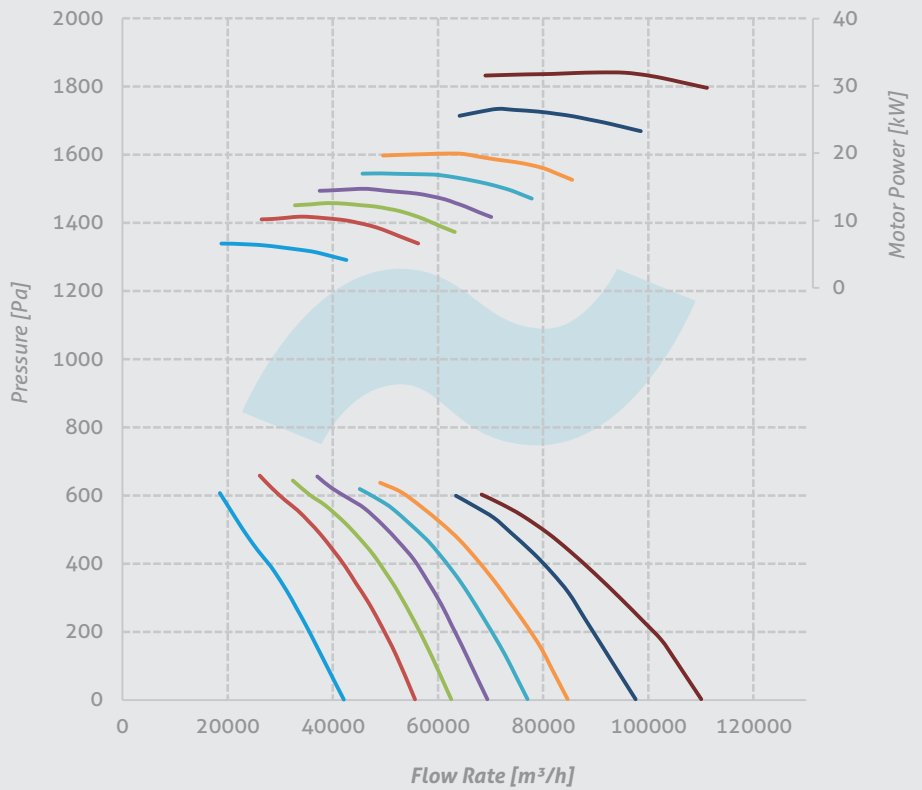

P-FWA 1120

Nos. of Blades 12
 Hub Size 12
 Nos. of Poles 6
 Material Aluminum
 Pitch Angle

- 25° — 30° — 32,5°
- 35° — 37,5° — 40°
- 45° — 50°

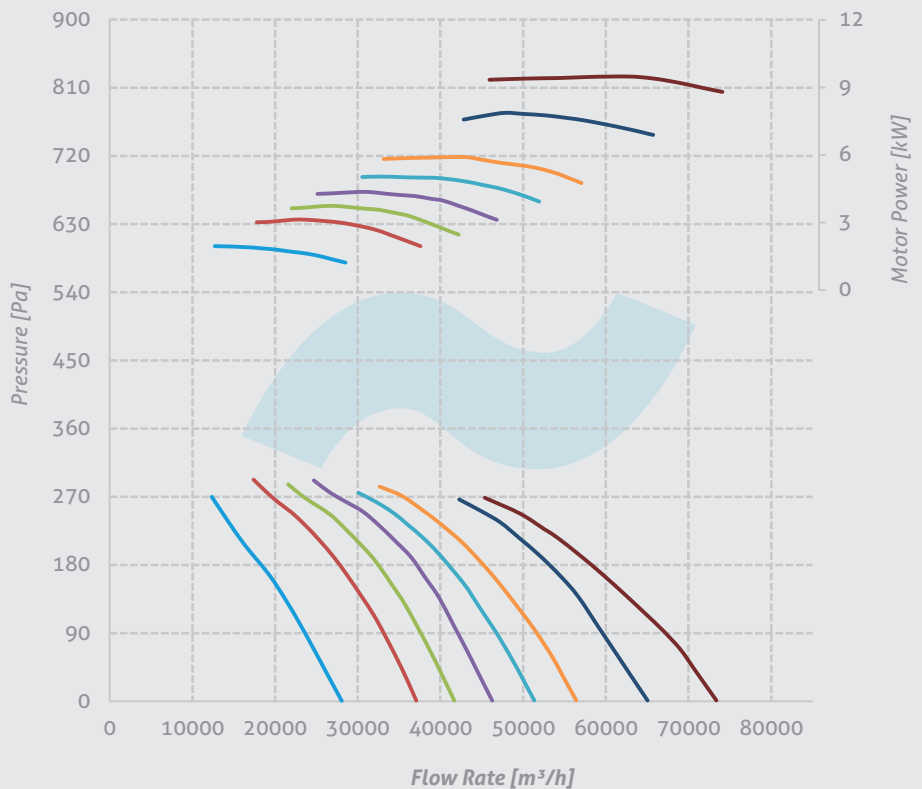

Performance Curves

P-FWA 1250

Nos. of Blades 8
 Hub Size 16
 Nos. of Poles 4
 Material Aluminum
 Pitch Angle

- 25° — 30° — 32,5°
- 35° — 37,5° — 40°
- 45° — 50°

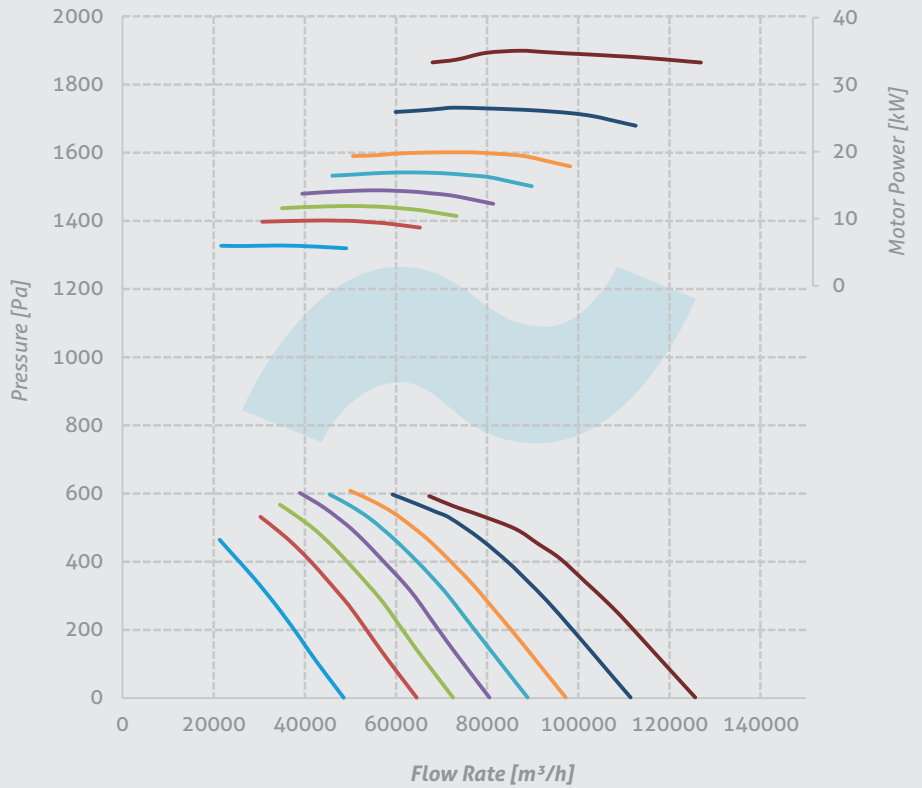

P-FWA 1250

Nos. of Blades 8
 Hub Size 16
 Nos. of Poles 6
 Material Aluminum
 Pitch Angle

- 25° — 30° — 32,5°
- 35° — 37,5° — 40°
- 45° — 50°

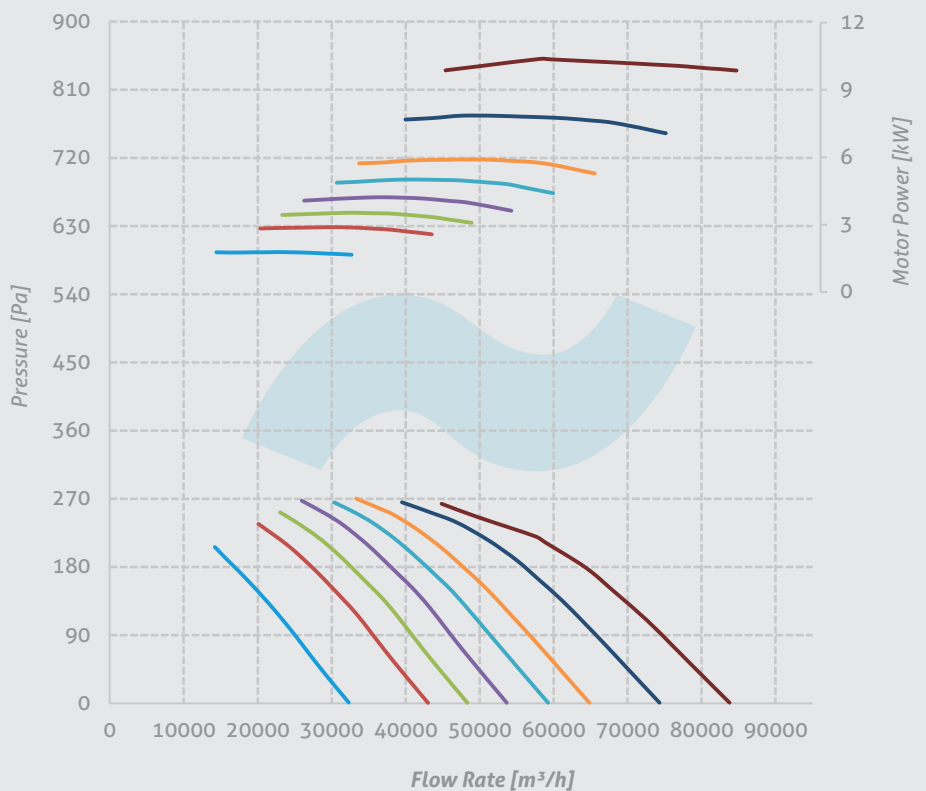

Performance Curves

P-FWA 1250

Nos. of Blades 12
 Hub Size 16
 Nos. of Poles 4
 Material Aluminum
 Pitch Angle

- 25° — 30° — 32,5°
- 35° — 37,5° — 40°
- 45° — 50°

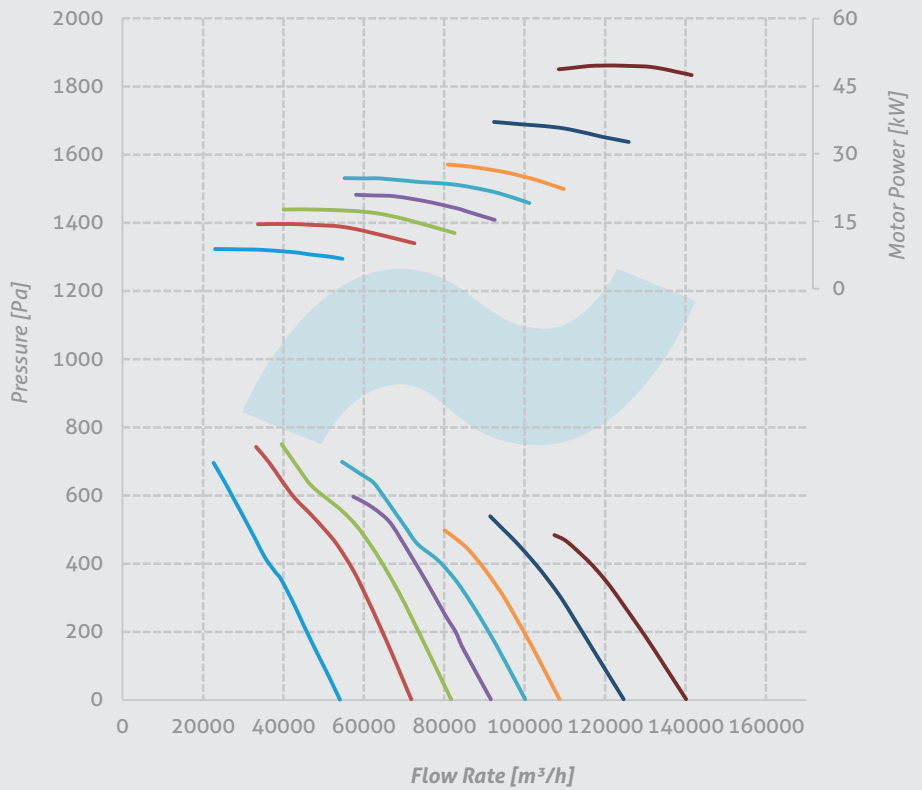

P-FWA 1250

Nos. of Blades 12
 Hub Size 16
 Nos. of Poles 6
 Material Aluminum
 Pitch Angle

- 25° — 30° — 32,5°
- 35° — 37,5° — 40°
- 45° — 50°

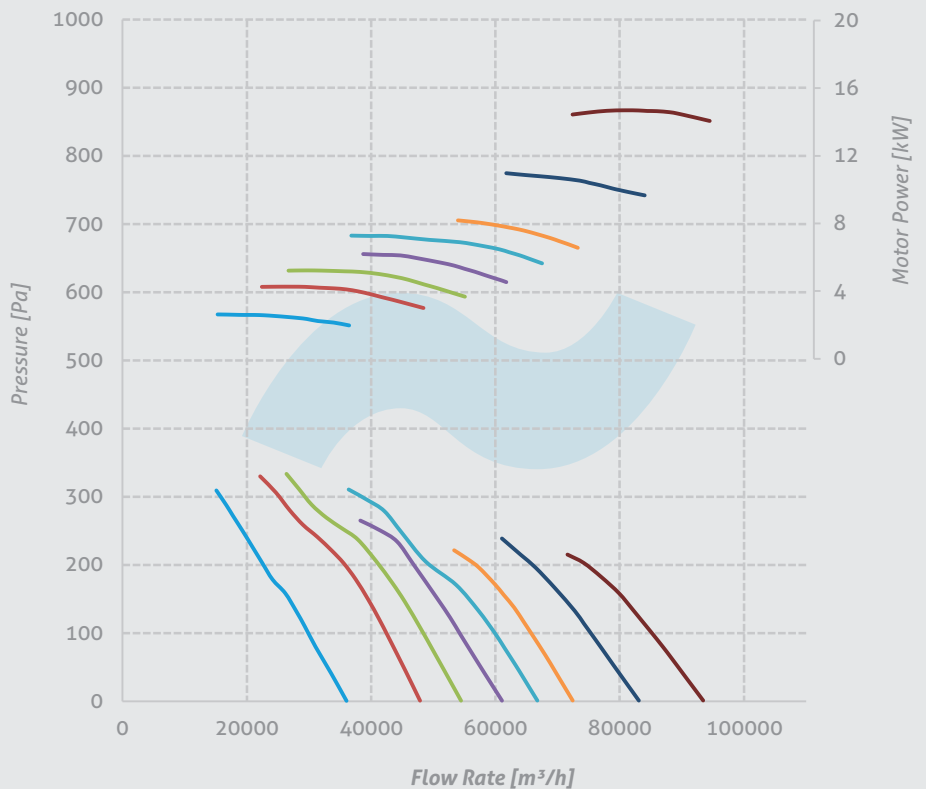

Performance Curves

P-FWA 1250

Nos. of Blades 16
 Hub Size 16
 Nos. of Poles 4
 Material Aluminum
 Pitch Angle

- 25° — 30° — 32,5°
- 35° — 37,5° — 40°
- 45° — 50°

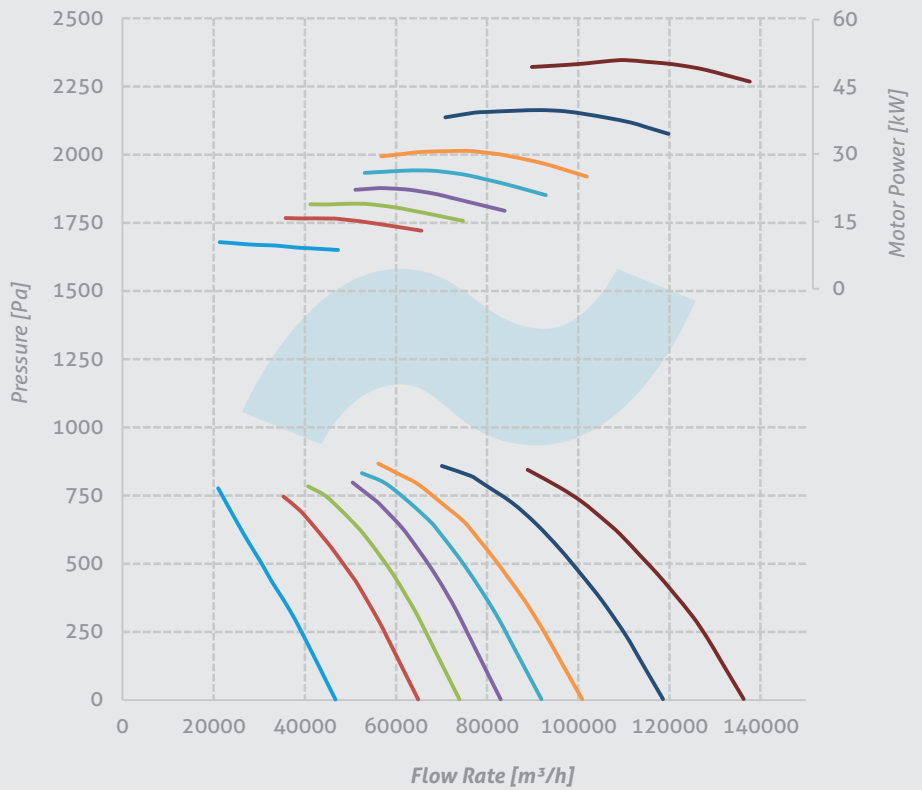

P-FWA 1250

Nos. of Blades 16
 Hub Size 16
 Nos. of Poles 6
 Material Aluminum
 Pitch Angle

- 25° — 30° — 32,5°
- 35° — 37,5° — 40°
- 45° — 50°

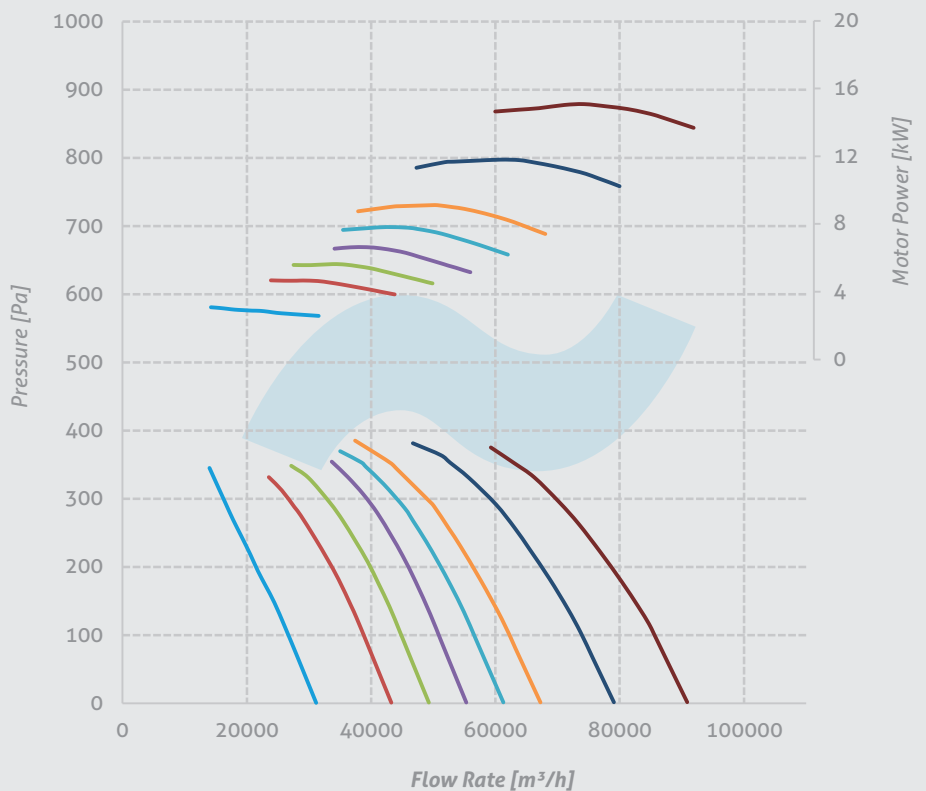

fanturkey

HVAC Expert

Contact Information:

*Address: Minareliçavuş OSB Mah. 202. Sk. N:19 Nilüfer / BURSA /
TURKEY*

Export & International Operations Manager:

Mr. Aslan TEKİN

Mobile: +90 552 616 40 57 (WhatsApp, Viber, Telegram)

Group Mail: export@fanturkey.com

Ukraine Representative:

Mr. Soshenko Konstantin

Mobile: +380 685 83 50 31 (WhatsApp, Viber, Telegram)

fanturkey.com