

**OBF**  
**Medium Pressure**  
**Centrifugal Fan**

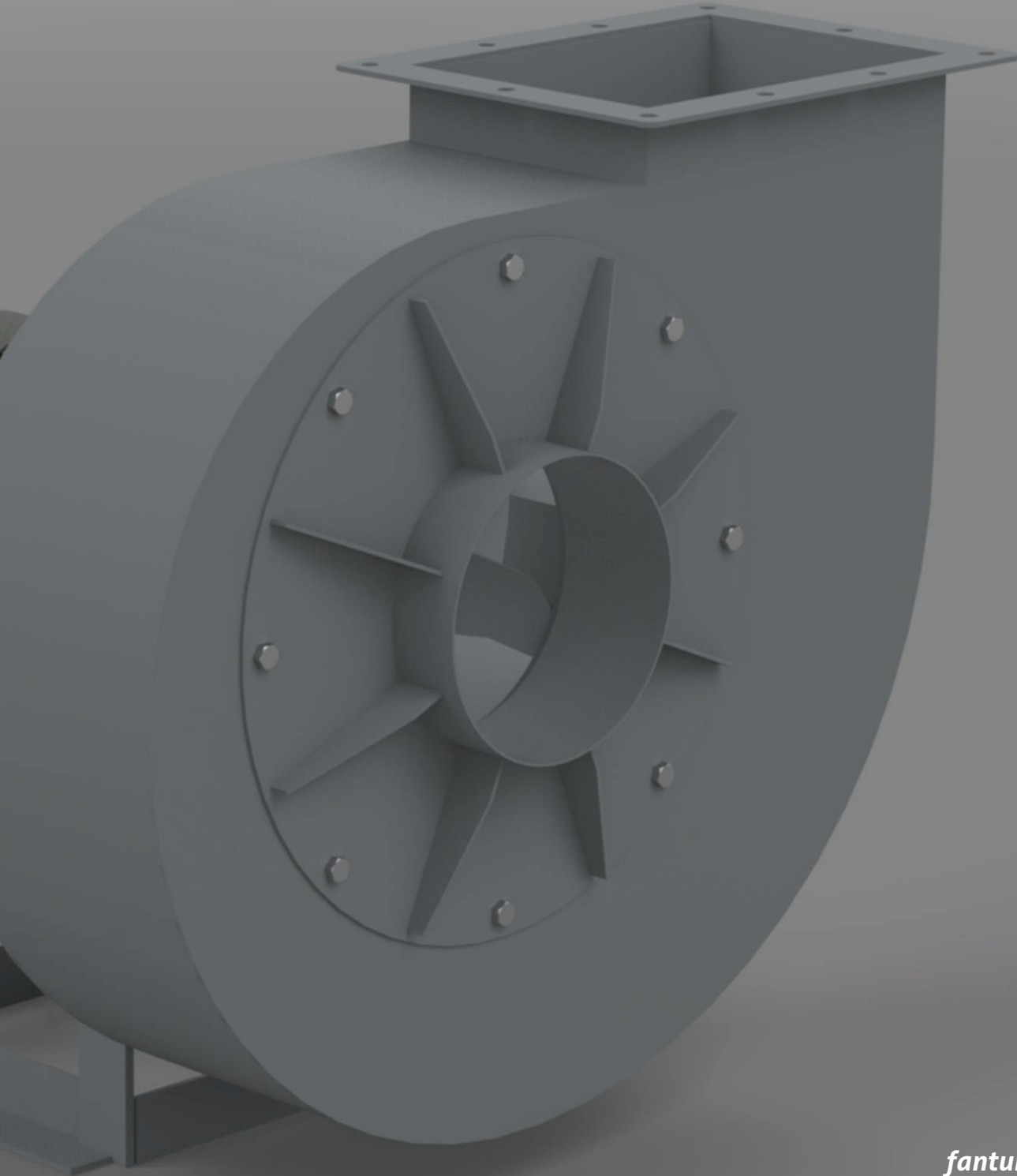

## Technical Specifications

# MEDIUM PRESSURE CENTRIFUGAL FAN

OBF series are single suction high efficiency and low noise fans. The maximum temperature of the suction fluid should be 80 ° C. In order to work at a higher temperature, modifications to the fan manufacturing are required.

Made of high quality corrosion resistant S355 steel and coated with epoxy paint. Can be made of stainless steel for corrosive and high temperature environments. Fans are radial fans with backward curved blades. It is possible to drive the fan with belt pulley, direct coupling or elastic coupling.

Optionally, it can be manufactured with Ex-Proof feature.

### Usage Areas

It is suitable for use in dusty air suction, ventilation, drying, mechanical extraction, dust, sawdust or any kind of ventilation systems with toxic gas systems.

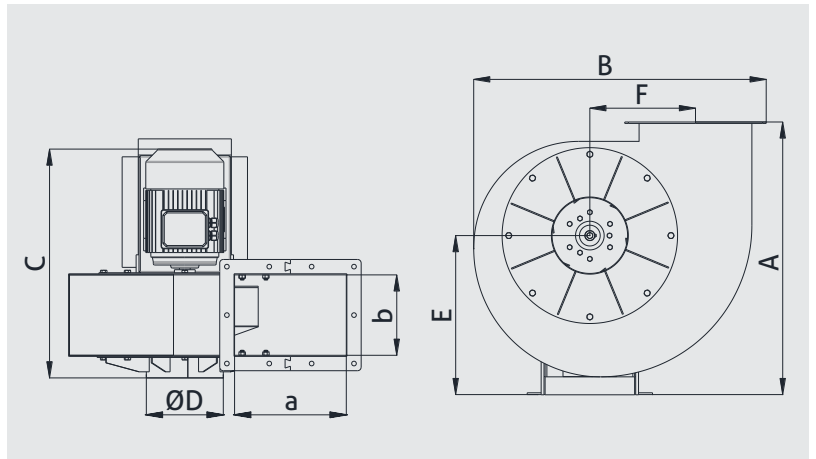
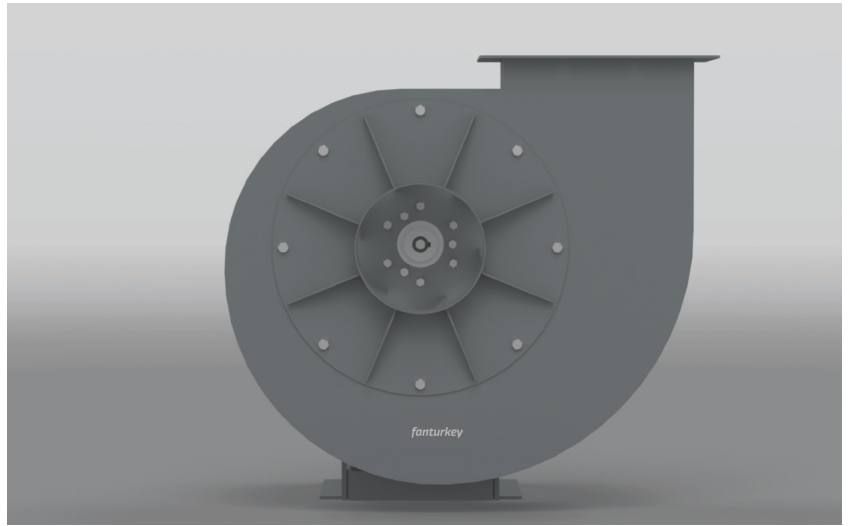

MODEL	A	B	C	Inlet ØD	Outlet a x b	E	F	VOLTAGE V	FREQUENCY Hz	MOTOR POWER kW	CURRENT A	MOTOR SPEED rpm	SOUND PRESSURE LEVEL dBA	WEIGHT kg
	mm	mm	mm	mm	mm	mm	mm							
OBF 100	415	405	345	105	140x100	243	135	380	50	0,18	0,8	2820	62	19
OBF 140	520	515	415	120	200x140	316	175	380	50	0,37	1,2	2800	65	27
OBF 160	520	580	445	155	225x160	294	205	380	50	0,55	1,6	2780	68	31
OBF 180	580	640	490	160	250x180	341	225	380	50	1,1	2,8	2900	72	46
OBF 200	665	720	545	215	275x200	389	263	380	50	2,2	5,7	2900	73	62
OBF 224	760	815	635	215	315x225	443	295	380	50	4	9	2910	77	79
OBF 250	815	905	720	235	355x250	479	327	380	50	7,5	15,2	2910	82	115
OBF 280	890	1015	905	265	400x280	519	370	380	50	11	22	2945	84	166
OBF 315	975	1145	910	320	450x315	580	407	380	50	18,5	35,6	2930	87	211



# Fan Directions

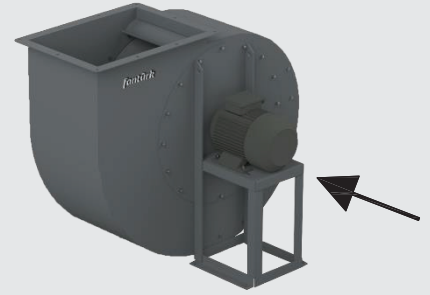

The centrifugal fan direction must be specified when ordering.

To determine the fan direction, one of the following options is selected when looking from the motor side.

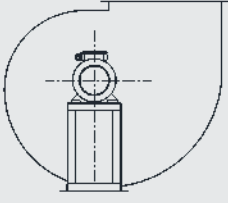
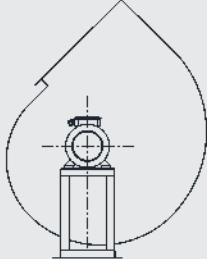
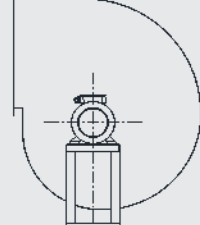
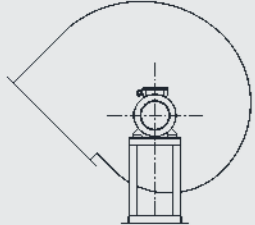
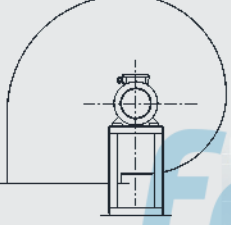
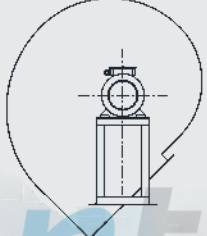
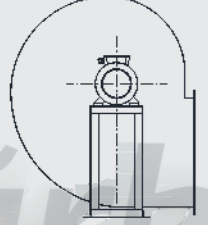
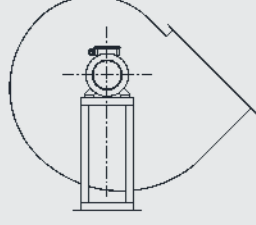

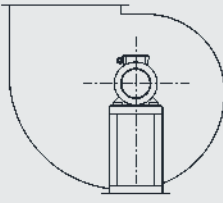
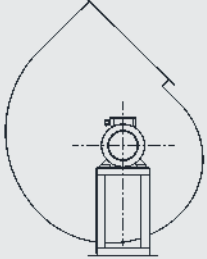
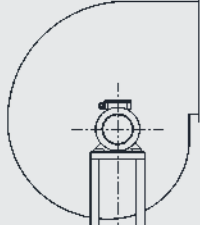
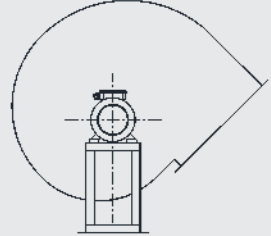
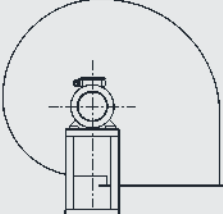
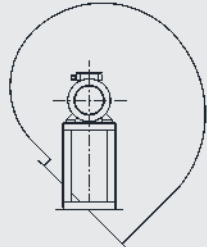
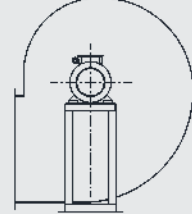
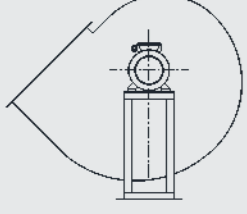
<b>Counter Clockwise</b> 	<b>TR</b> Top Right	<b>TR45</b> Top Right 45°	<b>LT</b> Left Top	<b>LT45</b> Left Top 45°
				
	<b>BL</b> Bottom Left	<b>BL45</b> Bottom Left 45°	<b>RB</b> Right Bottom	<b>RB45</b> Right Bottom 45°
				
<b>Clockwise</b> 	<b>TL</b> Top Left	<b>TL45</b> Top Left 45°	<b>RT</b> Right Top	<b>RT45</b> Right Top 45°
				
	<b>BR</b> Bottom Right	<b>BR45</b> Bottom Right 45°	<b>LB</b> Left Bottom	<b>LB45</b> Left Bottom 45°
				

## Performance Curves

### **OBF 100/0,18**

Voltage 380 V  
Frequency 50 Hz  
Motor Power 0,18 kW  
Motor Speed 2820 rpm  
Sound Pressure Level 62 dBA  
Weight 19 kg

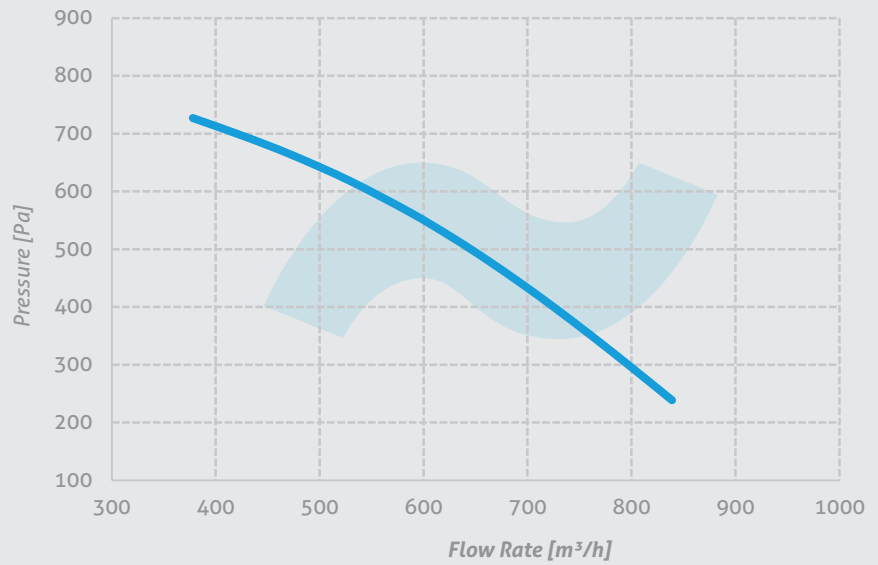

### **OBF 140/0,37**

Voltage 380 V  
Frequency 50 Hz  
Motor Power 0,37 kW  
Motor Speed 2800 rpm  
Sound Pressure Level 65 dBA  
Weight 27 kg

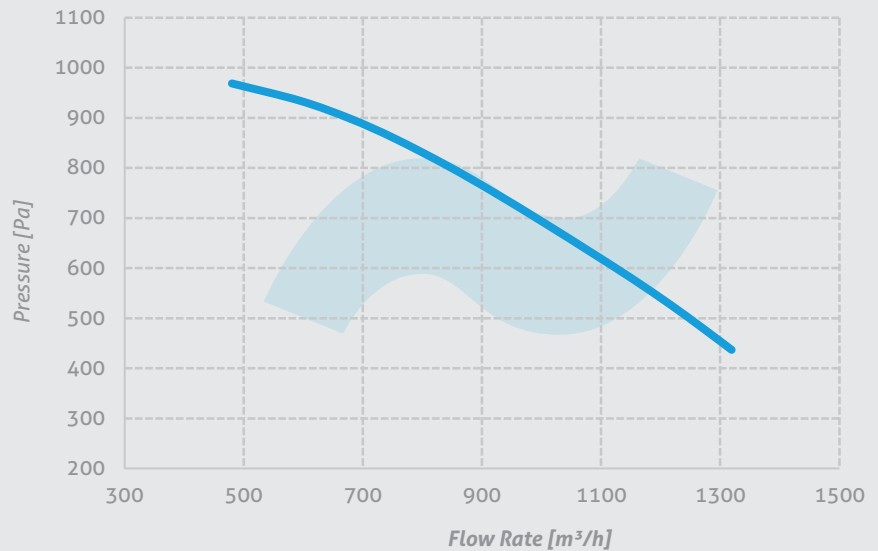

### **OBF 160/0,55**

Voltage 380 V  
Frequency 50 Hz  
Motor Power 0,55 kW  
Motor Speed 2780 rpm  
Sound Pressure Level 68 dBA  
Weight 31 kg

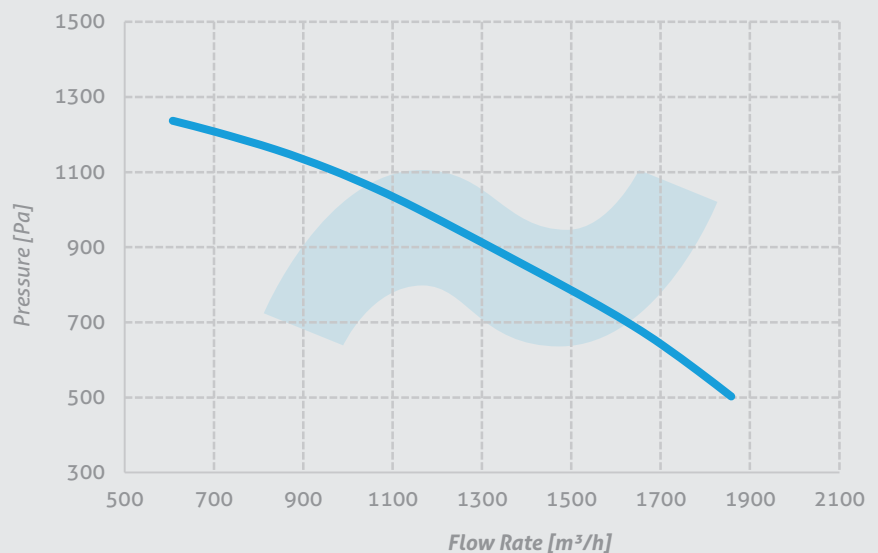

## Performance Curves

### OBF 180/1,1

Voltage 380 V  
Frequency 50 Hz  
Motor Power 1,1 kW  
Motor Speed 2900 rpm  
Sound Pressure Level 72 dBA  
Weight 46 kg

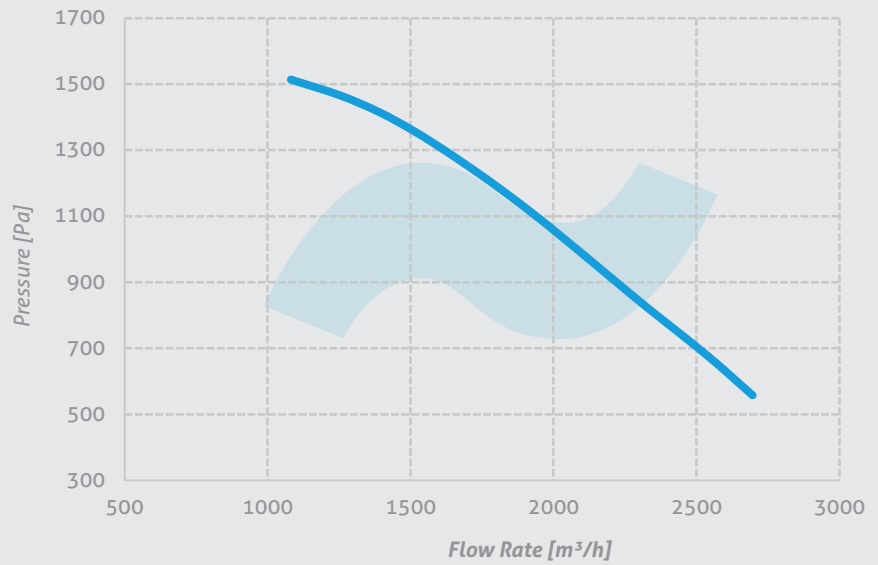

### OBF 200/2,2

Voltage 380 V  
Frequency 50 Hz  
Motor Power 2,2 kW  
Motor Speed 2900 rpm  
Sound Pressure Level 73 dBA  
Weight 62 kg

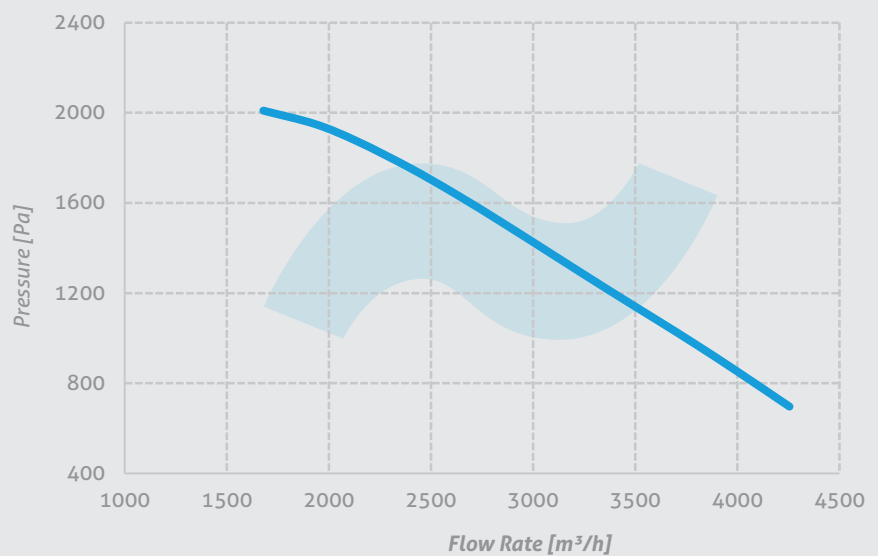

### OBF 224/4

Voltage 380 V  
Frequency 50 Hz  
Motor Power 4 kW  
Motor Speed 2910 rpm  
Sound Pressure Level 77 dBA  
Weight 79 kg

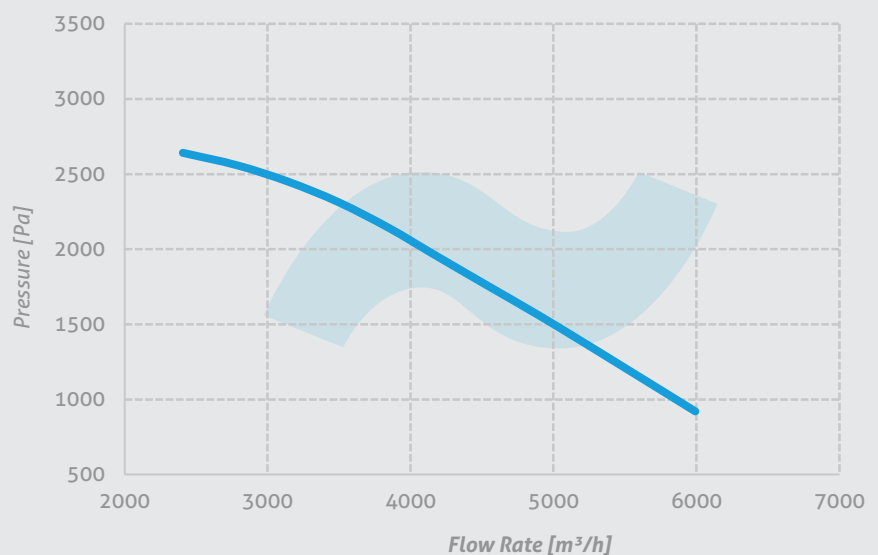

# Performance Curves

## OBF 250/7,5

Voltage 380 V  
Frequency 50 Hz  
Motor Power 7,5 kW  
Motor Speed 2910 rpm  
Sound Pressure Level 82 dBA  
Weight 115 kg

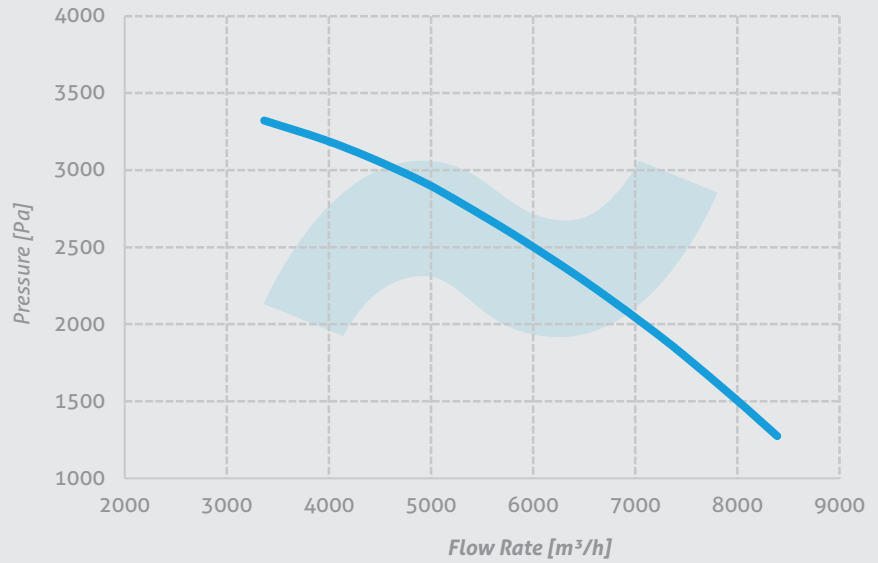

## OBF 280/11

Voltage 380 V  
Frequency 50 Hz  
Motor Power 11 kW  
Motor Speed 2945 rpm  
Sound Pressure Level 62 dBA  
Weight 166 kg

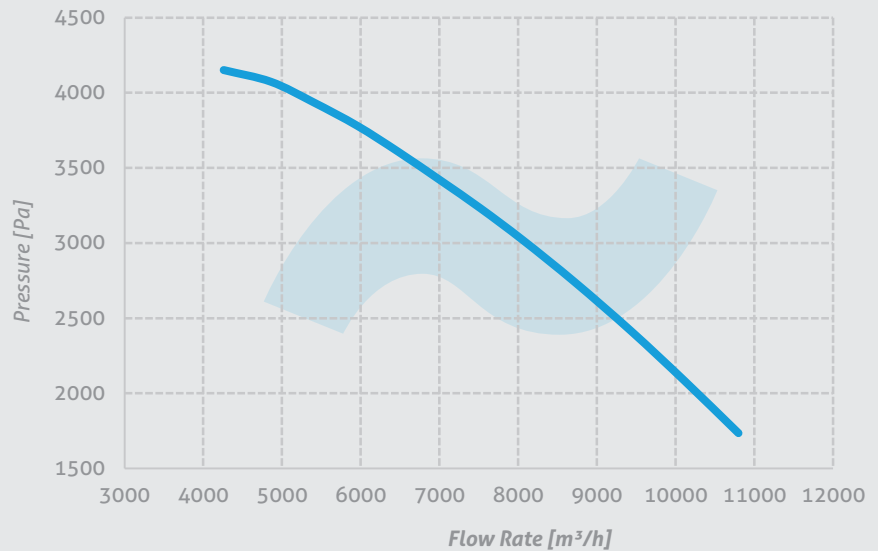

## OBF 315/18,5

Voltage 380 V  
Frequency 50 Hz  
Motor Power 18,5 kW  
Motor Speed 2930 rpm  
Sound Pressure Level 87 dBA  
Weight 211 kg

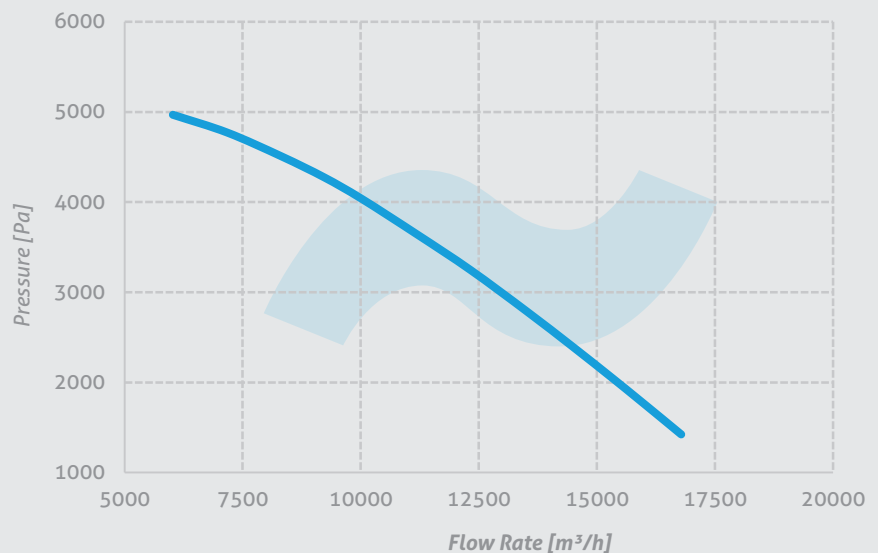

# *fanturkey*

## *HVAC Expert*

### *Contact Information:*

*Address: Minareliçavuş OSB Mah. 202. Sk. N:19 Nilüfer / BURSA /  
TURKEY*

### *Export & International Operations Manager:*

*Mr. Aslan TEKİN*

*Mobile: +90 552 616 40 57 (WhatsApp, Viber, Telegram)*

*Group Mail: [export@fanturkey.com](mailto:export@fanturkey.com)*

### *Ukraine Representative:*

*Mr. Soshenko Konstantin*

*Mobile: +380 685 83 50 31 (WhatsApp, Viber, Telegram)*

*[fanturkey.com](http://fanturkey.com)*