

D-KTF
Rectangular Duct
Type In-Line Fan



Technical Specifications

RECTANGULAR DUCT TYPE IN-LINE FAN

D-KTF series rectangular duct type radial fans; They are the ideal fans for ducted ventilation systems where high air flow and high pressure are required. Thanks to their compact construction, they can be installed directly in the air ducts without the need for large bends and transducers in any position required. D-KTF series in-line fans are the ideal choice for high performance and trouble-free operation.

Made of high quality corrosion resistant galvanized steel. Fans are radial fans with backward curved blades. Thanks to the service cover, the fan can be carry out maintenance without removing the duct connection. Motors are single phase and has IP44 and Class F insulation. Speed controller is optional for all models.

Usage Areas

Can be used for ventilation systems in industrial buildings, kitchens, toilets, swimming pools, gyms, warehouses, hospitals, offices, laboratories, shopping malls, restaurants, theaters, residential buildings.

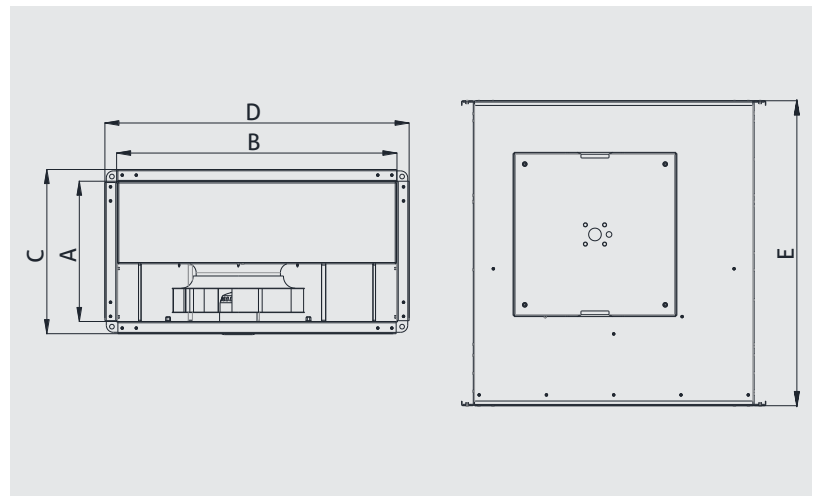

MODEL	A	B	C	D	E	VOLTAGE	FREQUENCY	MOTOR POWER	CURRENT	CAPACITOR	MOTOR SPEED	FLOW RATE	SOUND PRESSURE LEVEL	WEIGHT
	mm	mm	mm	mm	mm	V	Hz	W	A	µf	rpm	m ³ /h	dBA	kg
D-KTF 30 - 15	150	300	200	350	400	230	50	66	0,3	3	2300	540	48	7
D-KTF 40 - 20A	200	400	250	450	500	230	50	100	0,47	3	2580	800	53	11
D-KTF 40 - 20B	200	400	250	450	500	230	50	150	0,7	4	2600	1020	55	12
D-KTF 50 - 25	250	500	300	550	550	230	50	200	0,9	6	2600	1520	56	16
D-KTF 60 - 30	300	600	350	650	650	230	50	250	1,1	8	2500	1840	50	20
D-KTF 60 - 35	350	600	400	650	750	230	50	210	1	8	1400	2520	53	27
D-KTF 70 - 40	400	700	450	750	800	230	50	500	1,8	12	1380	4100	60	38
D-KTF 80 - 50	500	800	550	850	900	230	50	500	2,2	12	1300	5600	64	61
D-KTF 100 - 50	500	1000	550	1050	1050	230	50	1560	2,9	31	1330	7600	66	86

Performance Curves

D-KTF 30 - 15

Voltage 230 V
Frequency 50 Hz
Motor Power 66 W
Current 0,3 A
Capacitor 3 μ f
Motor Speed 2300 rpm
Flow Rate 540 m³/h
Sound Pressure Level 48 dBA
Weight 7 kg

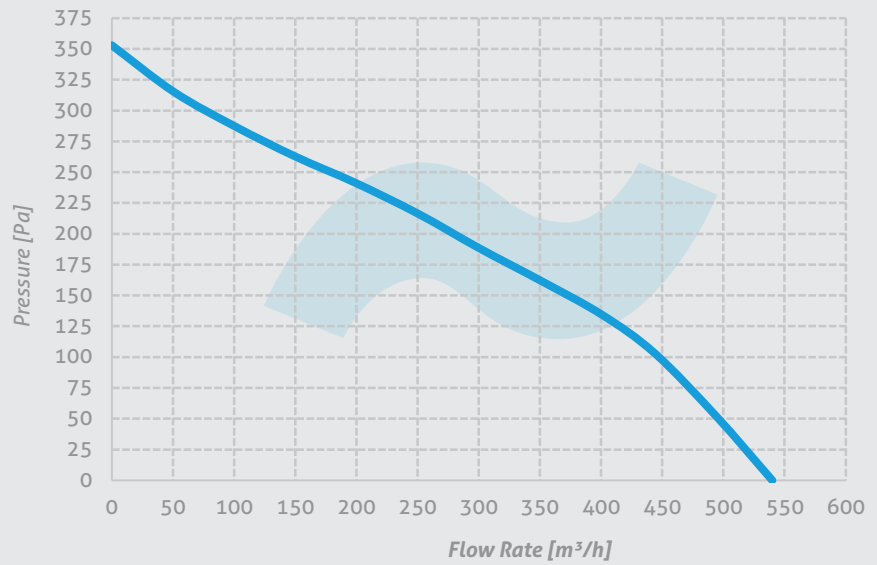

D-KTF 40 - 20A

Voltage 230 V
Frequency 50 Hz
Motor Power 100 W
Current 0,47 A
Capacitor 3 μ f
Motor Speed 2580 rpm
Flow Rate 800 m³/h
Sound Pressure Level 53 dBA
Weight 11 kg

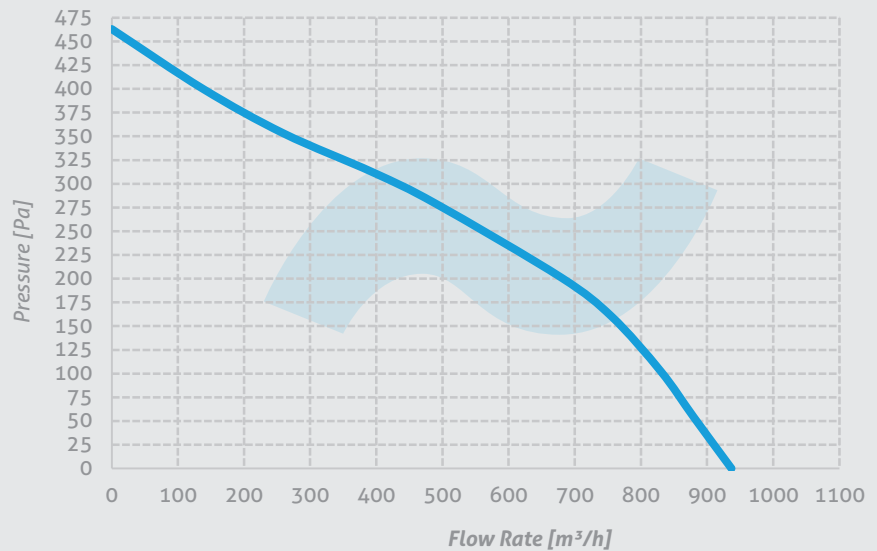

D-KTF 40 - 20B

Voltage 230 V
Frequency 50 Hz
Motor Power 150 W
Current 0,7 A
Capacitor 4 μ f
Motor Speed 2600 rpm
Flow Rate 1020 m³/h
Sound Pressure Level 55 dBA
Weight 12 kg

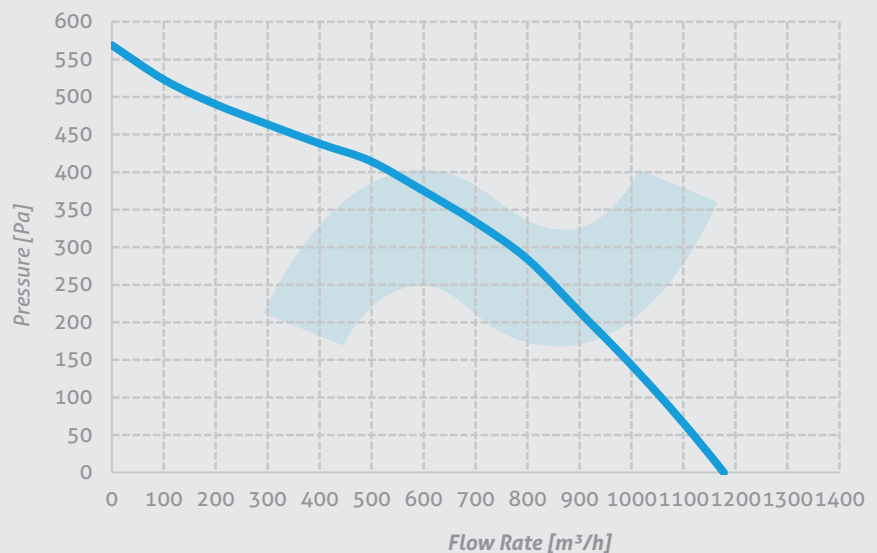

Performance Curves

D-KTF 50 - 25

Voltage 230 V
Frequency 50 Hz
Motor Power 200 W
Current 0,9 A
Capacitor 6 μ f
Motor Speed 2600 rpm
Flow Rate 1520 m³/h
Sound Pressure Level 56 dBA
Weight 16 kg

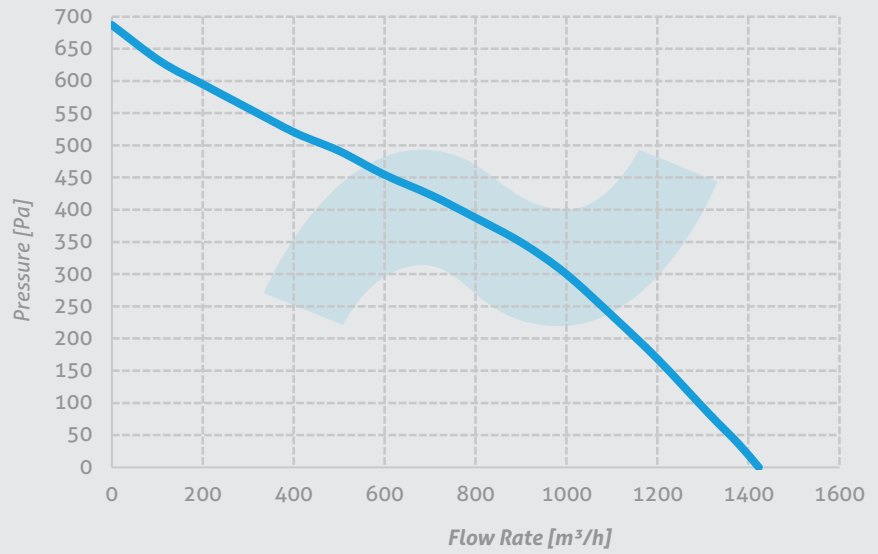

D-KTF 60 - 30

Voltage 230 V
Frequency 50 Hz
Motor Power 250 W
Current 1,1 A
Capacitor 8 μ f
Motor Speed 2500 rpm
Flow Rate 1840 m³/h
Sound Pressure Level 50 dBA
Weight 20 kg

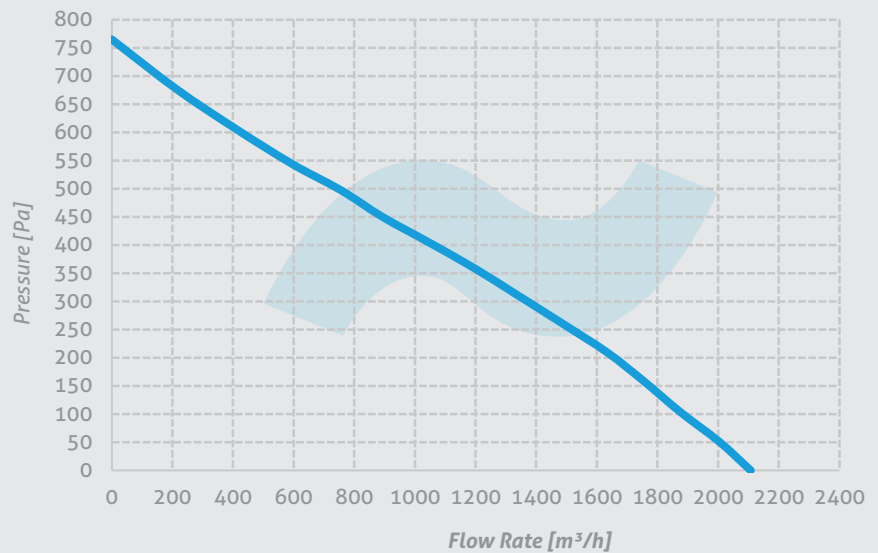

D-KTF 60 - 35

Voltage 230 V
Frequency 50 Hz
Motor Power 210 W
Current 1 A
Capacitor 8 μ f
Motor Speed 1400 rpm
Flow Rate 2520 m³/h
Sound Pressure Level 53 dBA
Weight 27 kg

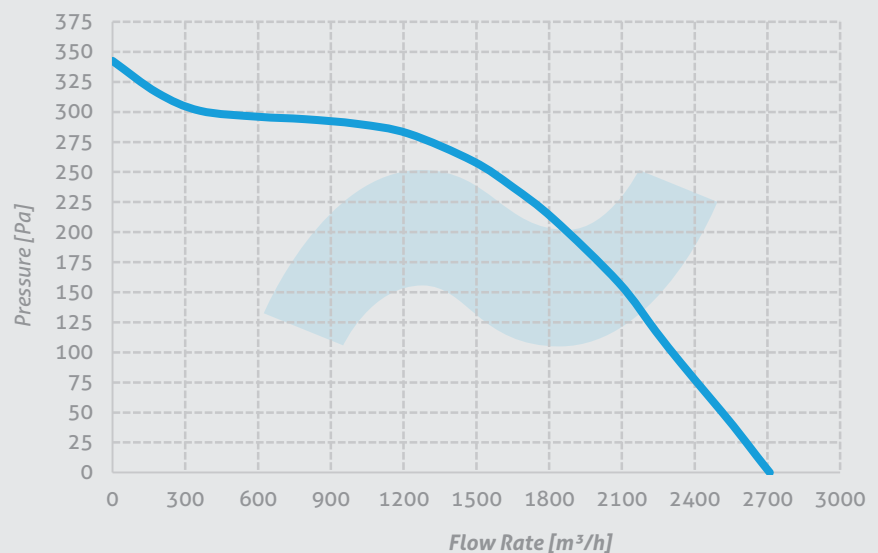

Performance Curves

D-KTF 70 - 40

Voltage 230 V
Frequency 50 Hz
Motor Power 500 W
Current 1,8 A
Capacitor 12 μ f
Motor Speed 1380 rpm
Flow Rate 4100 m³/h
Sound Pressure Level 60 dBA
Weight 38 kg

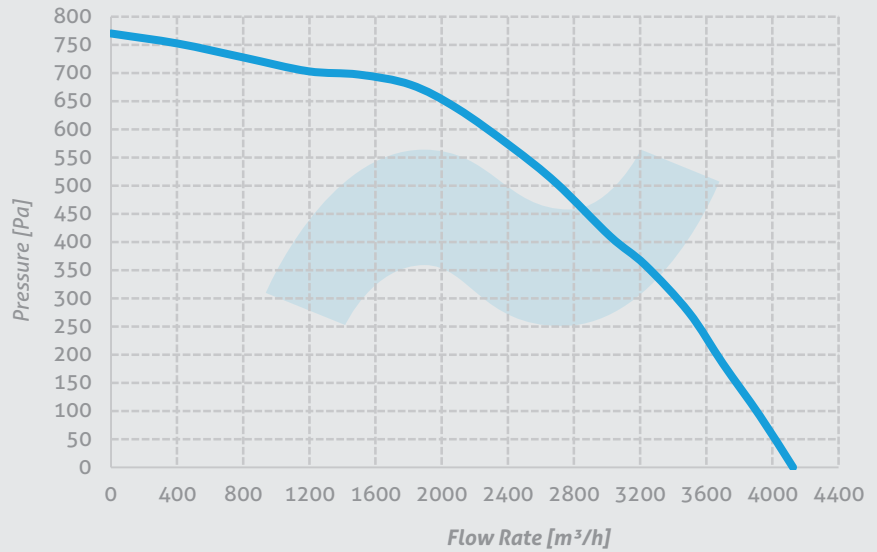

D-KTF 80 - 50

Voltage 230 V
Frequency 50 Hz
Motor Power 500 W
Current 2,2 A
Capacitor 12 μ f
Motor Speed 1300 rpm
Flow Rate 5600 m³/h
Sound Pressure Level 64 dBA
Weight 61 kg

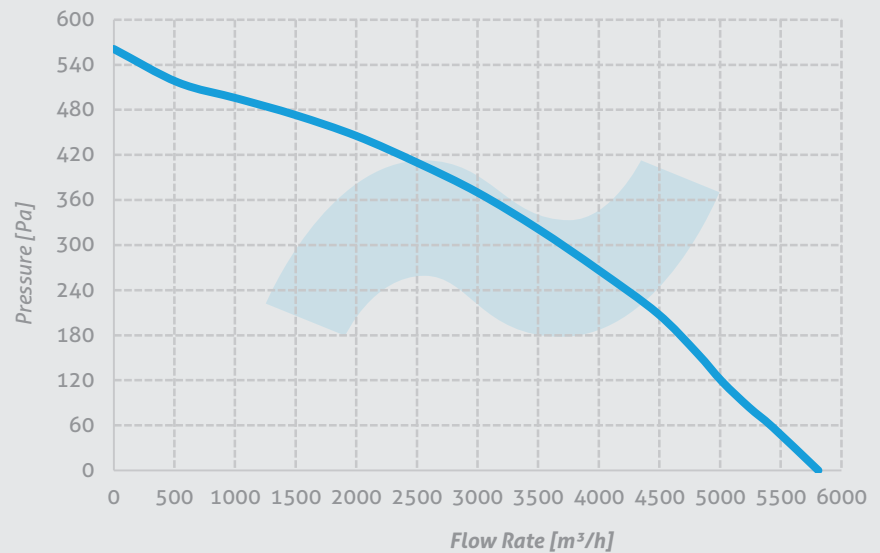

D-KTF 100 - 50

Voltage 230/380 V
Frequency 50 Hz
Motor Power 1560 W
Current 2,9 A
Capacitor 31 μ f
Motor Speed 1330 rpm
Flow Rate 7600 m³/h
Sound Pressure Level 66 dBA
Weight 86 kg

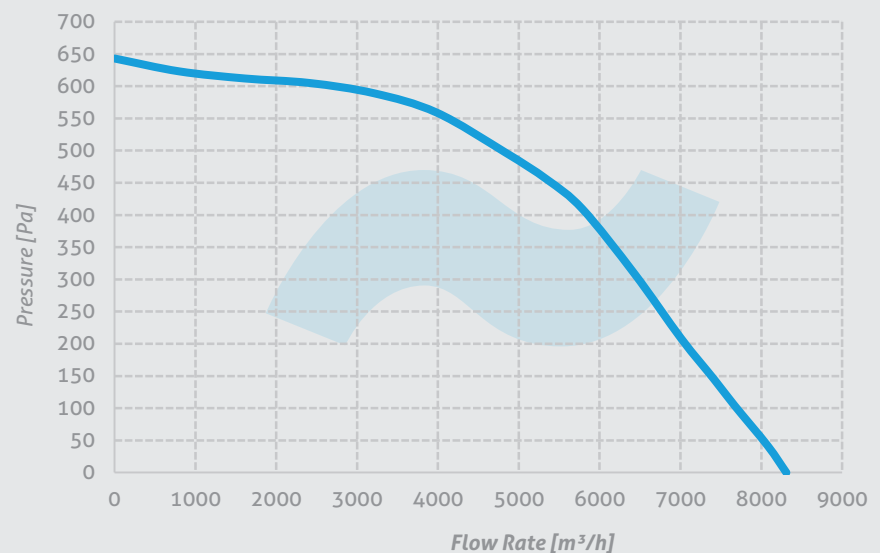

fanturkey

HVAC Expert

Contact Information:

*Address: Minareliçavuş OSB Mah. 202. Sk. N:19 Nilüfer / BURSA /
TURKEY*

Export & International Operations Manager:

Mr. Aslan TEKİN

Mobile: +90 552 616 40 57 (WhatsApp, Viber, Telegram)

Group Mail: export@fanturkey.com

Ukraine Representative:

Mr. Soshenko Konstantin

Mobile: +380 685 83 50 31 (WhatsApp, Viber, Telegram)

fanturkey.com